

VESSEL

BITS & SOCKETS





Construction Bits	104 - 127
Construction Sockets	128 - 139
Drill Bits / Drill Chucks	140 - 145

BITS & SOCKETS



Extra Superalloy

VESSEL's original bit material that combines strength and toughness.

- » 105
- » 110
- » 112
- » 113
- » 115
- » 116
- » 118
- » 121
- » 133

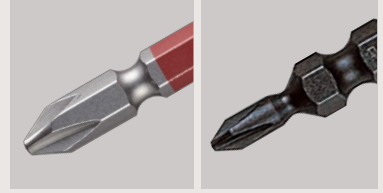

Rib (Reinforced tip-end) Patented

The RIB BIT was developed with a new idea of adding ribs to the tip-end. Combining with the optimal torsion part, it has realized excellent torque transmission and high durability. With high strength, this bit shows superb durability for various work.

- » 113
- » 119
- » 122



GIZA/Zigzag

The jagged tip of our GIZA/Zigzag BITS prevents cam-out which tends to occur when tightening cross-head screws. At the moment when the bit starts to slip out of the screw head, the jagged edges bite into the internal side of the screw recess. Good for screw tightening in a poor footing and unstable place.

- » 113
- » 124
- » 137

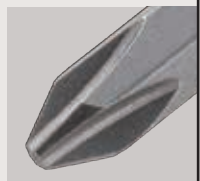

Extra Hard

Our EXTRA HARD BITS is hardened to a maximum hardness of 62 HRC. Good for relatively hard screws such as stainless steel screws and board screws.

- » 124



Tapping

Our TAPPING BITS are designed with thick wings and short flutes for extra strength, making them ideal for heavy-duty work such as driving sash screws of greater than 4mm in diameter.

- » 124



Slender

Our SLENDER BITS have a thin tip-end with the advantage to let the screw head be seen well. Good for soft joint work such as wood screws and resin tapping screws.

- » 112
- » 123



JAWS Patented

Our JAWS BITS are perfect for working with wood screws. From start to finish, these bits bite into the screw head recess, allowing for increased work efficiency without fallen screws.

- » 124



SAKISUBO

The constricted part of the bit reduces the vibration that is caused when the screw starts to enter the material and passes through wood



grain, preventing cam-out and allowing efficient work.

- » 115
- » 119

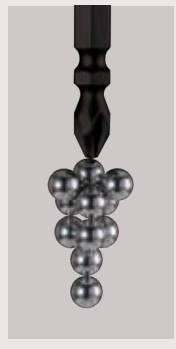

Magnetized bits

These bits can catch screws with a strong magnetic force for improved work efficiency.

RoHS

Environmental Measures

Pb (lead) / Cd (cadmium) / Hg (mercury) / Hexavalent chromium / PBB (polybrominated biphenyl) / PBDE (polybrominated diphenyl ether) / DEHP, BBP, DBP, DIBP (phthalate esters)

The products with this mark in this catalogue are compliant with the RoHS directives (EU) (usage limit of the above 10 substances).

Note: For the updated information on RoHS compliant products, visit our homepage, because some products or sizes are under investigation or are not compliant at the time of publication of this catalogue.



Drive

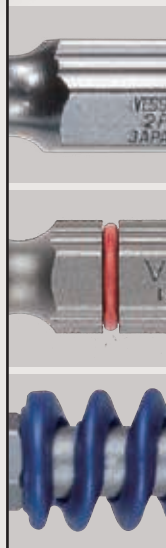
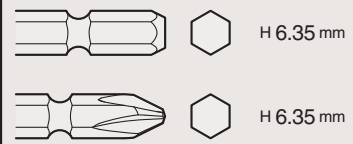

Ultra Hex®

Special hexagonal cross section composed of the flat surfaces and the wavy surfaces. The latter fit the inner side of the chuck, improving driving efficiency. In the meantime, the former prevent the shank from getting stuck in the chuck and reduce damages to it.

» 122
» 123

Cushion ring (Prevents center run-out)

By minimizing the gap between the chuck and the bit, rattling and vibration are reduced.

» 112
» 123
» 141
» 144

Plastic spring

The bit goes out of the chuck smoothly with a help of spring when the chuck sleeve is pulled, allowing users to take out the bit with one hand. Also useful to take out a heated bit to replace.

» 122

Carefully selected materials

With our long experience and research in manufacturing, we developed our own materials with hardness (less wearing) and toughness (hard to chip). Properties of the elements contained in the materials have been improved to an optimal level through a heat treatment process.

C Carbon

The more carbon is contained, the greater hardening penetration becomes. When the carbon content is 0.6% or more, abrasion resistance increases, although hardening penetration remains the same.

Ni Nickel

The addition of small amount of nickel increases steel's shock resistance and toughness. When added in a large amount, it becomes weak and breaks easily.

Cr Chrome

Hardenability increases. Oxidation resistance increases. Toughness is improved.

Mo Molybdenum

Hardenability increases. Significant decrease in toughness can be prevented.

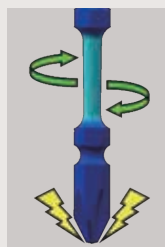

Torsion part

Torsion part absorbs the impact caused when the screw head is seated by using an impact driver, and prevents tip breakage.



φ3.5×20mm

For soft joint with wood screws. Good for fastening soft materials.

φ3.7×14mm

For hard joint with drill screws. Good for fastening hard materials.

» 115
» 119
» 122

GS

"GOSAI" Bits

Original Extra Superalloy makes the bits strong and tough.



Our original new material, Extra Superalloy, is a special alloy that adds stronger and more flexible properties to bits. Extra Superalloy bits are hard, tough, and resistant to breakage.

Max hardness: 62HRC

Extra Superalloy[※]

※Extra Superalloy is used for items and sizes in which material properties can be fully utilized.

"GOSAI" BIT is not only resistant to breakage or bending, but also transmits torque accurately and reliably, allowing screws to be tightened securely.

Comparison test with twisting tester

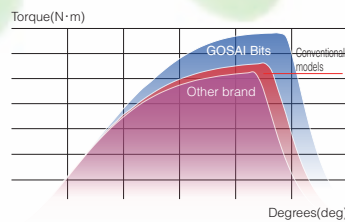

Screw Tightening Test

Tested with a wooden plate, N=5

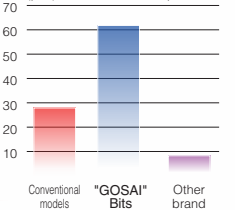

Precise tip-end machining. High quality fitting.

As the tip-end is not plated or painted, the cross shaped tip-end can fit various screws.

Tip-end 3D comparison (+0)

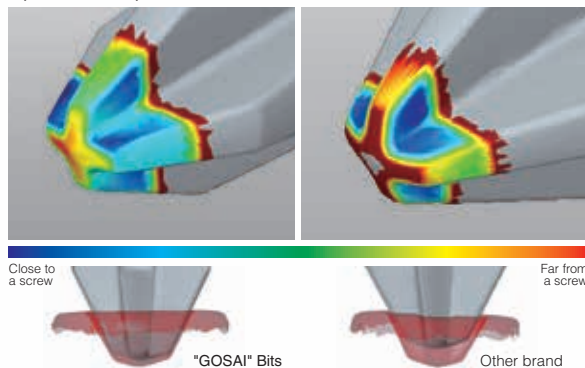

※Image is for illustration purposes.

GS14

Double End "GOSAI" bits

Different colors applied to each size.



HAND TOOLS
INDUSTRIAL BITS
CONSTRUCTION BITS
RECIPROCATING SAW BLADES
ELECTRIC TOOLS
AIR TOOLS
AIR NIPPERS
STATIC SOLUTIONS
GASOLINE ENGINE TOOLS

Double End "GOSAI" Bit | GS14

- Different colors applied to each size.
- Strong and tough Extra Superalloy adopted.

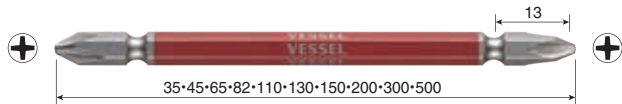

GS14 1035 GS14 1065 GS14 1110 GS14 2035 GS14 2045 GS14 2065 GS14 2082 GS14 2110 GS14 2130 GS14 2150



GS14 2200

GS14 2300

GS14 2500

Code No.	Model No.	Set Content	Card size (mm)	JAN (4907587)
485501	GS141035	⊕1× 35 1pc.	160×35×8	336019
485502	GS141065	⊕1× 65 2pcs.	160×35×8	336026
485503	GS141110	⊕1×110 2pcs.	160×35×8	336033
485504	GS142035	⊕2× 35 1pc.	160×35×8	336040
485505	GS142045	⊕2× 45 1pc.	160×35×8	336057
485506	GS142065	⊕2× 65 2pcs.	160×35×8	336064
485507	GS142082	⊕2× 82 2pcs.	160×35×8	336071
485508	GS142110	⊕2×110 2pcs.	160×35×8	336088
485509	GS142130	⊕2×130 2pcs.	180×35×8	336095
485510	GS142150	⊕2×150 2pcs.	180×35×8	336101
485511	GS142200	⊕2×200 1pc.	230×35×8	336118
485512	GS142300	⊕2×300 1pc.	340×35×8	336125
485513	GS142500	⊕2×500 1pc.	540×35×8	336132
485514	GS143035	⊕3× 35 1pc.	160×35×8	336149
485515	GS143065	⊕3× 65 2pcs.	160×35×8	336156
485516	GS143110	⊕3×110 2pcs.	160×35×8	336163
485517	GS143150	⊕3×150 2pcs.	180×35×8	336170
485519	GS144065	⊕4× 65 1pc.	135×35×8	336194

*Colors inside the table indicate the bit color.

SPQ: 10 sets

Double End "GOSAI" Bit 5-pc set | GS5P



GS5P2065 GS5P2082 GS5P2110 GS5P2130 GS5P2150

Code No.	Model No.	Set Content	Card size (mm)	JAN (4907587)
485552	GS5P2065	⊕2× 65 5pcs.	160×70×8	336521
485553	GS5P2082	⊕2× 82 5pcs.	160×70×8	336538
485554	GS5P2110	⊕2×110 5pcs.	160×70×8	336545
485555	GS5P2130	⊕2×130 5pcs.	180×70×8	336552
485556	GS5P2150	⊕2×150 5pcs.	180×70×8	336569

*Colors inside the table indicate the bit color.

SPQ: 10 sets

Double End "GOSAI" Bit, 10-pc set | GS10P NEW



GS10P2065F GS10P2110F

Code No.	Model No.	Set Content	Package size (mm)	JAN (4907587)
485638	GS10P2065F	⊕2× 65 10pcs.	140×87×7	027863
485639	GS10P2110F	⊕2×110 10pcs.	160×87×7	027870

*Colors inside the table indicate the bit color.

SPQ: 10 sets

"GOSAI" Bit Belt, 10-pc set | GS10P-01 NEW



Code No.	Model No.	Set Content	Card size (mm)	JAN (4907587)
485644	GS10P-01	Single End ⊕1×100 1pc.	150×100×25	031495
		Single End ⊕2×100 1pc.		
		Double End ⊕1× 65 1pc.		
		Double End ⊕2× 45 2pcs.		
		Double End ⊕2× 65 2pcs.		
		Double End ⊕2×110 1pc.		
		Double End ⊕3× 65 1pc.		
Combi ⊕2/⊕6×65 1pc.				

Comes with one bit holder SPQ: 10 sets

Double End Combi "GOSAI" Bit | GS14

- 2 different sizes are combined into one bit.
- Tip width [thickness] is as follows: $\ominus 5$ [0.8], $\ominus 6$ [1.0]

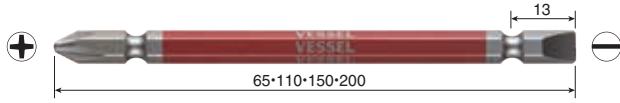

GS14 1211 GS14 2311 GS14 5665 GS14 5611 GS14 1565 GS14 1511 GS14 2665 GS14 2611 GS14 2615

GS14 2620

Code No.	Model No.	Set Content	Card size (mm)	JAN (4907587)
485520	GS141211	$\oplus 1/\oplus 2 \times 110$ 2pcs.	160×35×8	336200
485518	GS142311	$\oplus 2/\oplus 3 \times 110$ 2pcs.	160×35×8	336187
485550	GS145665	$\ominus 5/\ominus 6 \times 65$ 2pcs.	160×35×8	336507
485551	GS145611	$\ominus 5/\ominus 6 \times 110$ 2pcs.	160×35×8	336514
485521	GS141565	$\oplus 1/\ominus 5 \times 65$ 2pcs.	160×35×8	336217
485522	GS141511	$\oplus 1/\ominus 5 \times 110$ 2pcs.	160×35×8	336224
485523	GS142665	$\oplus 2/\ominus 6 \times 65$ 2pcs.	160×35×8	336231
485524	GS142611	$\oplus 2/\ominus 6 \times 110$ 2pcs.	160×35×8	336248
485525	GS142615	$\oplus 2/\ominus 6 \times 150$ 2pcs.	180×35×8	336255
485526	GS142620	$\oplus 2/\ominus 6 \times 200$ 1pc.	340×35×8	336262

※Colors inside the table indicate the bit color. SPQ: 10 sets

Double End Square "GOSAI" Bit | GS14SQ

- For square head screws, popular for sash and/or quake-proof hardware.

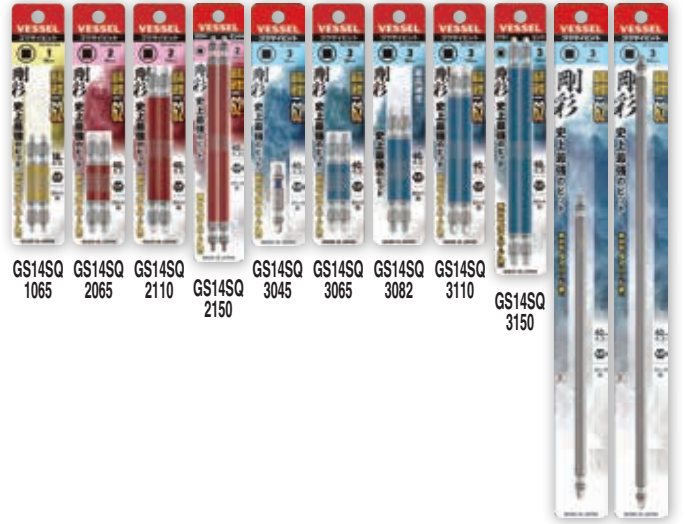
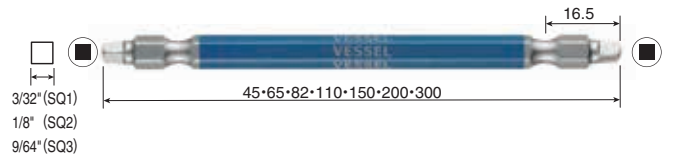

GS14SQ 1065 GS14SQ 2065 GS14SQ 2110 GS14SQ 2150 GS14SQ 3045 GS14SQ 3065 GS14SQ 3082 GS14SQ 3110 GS14SQ 3150 GS14SQ 3200 GS14SQ 3300

GS14SQ 3200 GS14SQ 3300

Code No.	Model No.	Set Content	Card size (mm)	JAN (4907587)
485623	GS14SQ1065	SQ1× 65 2pcs.	160×35×8	337238
485624	GS14SQ2065	SQ2× 65 2pcs.	160×35×8	337245
485625	GS14SQ2110	SQ2×110 2pcs.	160×35×8	337252
485626	GS14SQ2150	SQ2×150 2pcs.	180×35×8	337269
485627	GS14SQ3045	SQ3× 45 1pc.	160×35×8	337276
485628	GS14SQ3065	SQ3× 65 2pcs.	160×35×8	337283
485629	GS14SQ3082	SQ3× 82 2pcs.	160×35×8	337290
485630	GS14SQ3110	SQ3×110 2pcs.	160×35×8	337306
485631	GS14SQ3150	SQ3×150 2pcs.	180×35×8	337313
485632	GS14SQ3200	SQ3×200 1pc.	340×35×8	337320
485633	GS14SQ3300	SQ3×300 1pc.	340×35×8	337337

※Colors inside the table indicate the bit color. SPQ: 10 sets

Double End Posidriv "GOSAI" Bit | GSPZ

- For Posidriv screws.
- Special tip shape prevents cam-out.

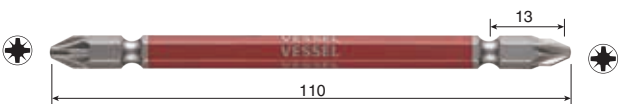

GSPZ 1110 GSPZ 2110 GSPZ 3110

Code No.	Model No.	Content	Card size (mm)	JAN (4907587)
485564	GSPZ1110	PZ1×110 1pc.	160×35×8	336644
485565	GSPZ2110	PZ2×110 1pc.	160×35×8	336651
485566	GSPZ3110	PZ3×110 1pc.	160×35×8	336668

※Colors inside the table indicate the bit color. SPQ: 10 sets

Double End Square "GOSAI" Bit, 5-pc set | GS5P



GS5P-42 GS5P-44

Code No.	Model No.	Set Content	Card size (mm)	JAN (4907587)
485634	GS5P-42	SQ3× 65 5pcs.	160×70×8	337344
485635	GS5P-44	SQ3×110 5pcs.	160×70×8	337351

※Colors inside the table indicate the bit color. SPQ: 10 sets

HAND TOOLS

INDUSTRIAL BITS

CONSTRUCTION BITS

RECIPROCATING SAW BLADES

ELECTRIC TOOLS

AIR TOOLS

AIR NIPPERS

STATIC SOLUTIONS

GASOLINE ENGINE TOOLS

Double End Square "GOSAI" Bit, 10-pc set | GS10PSQ NEW



GS10PSQ3065F

GS10PSQ3110F

Code No.	Model No.	Set Content	Package size (mm)	JAN (4907587)
485642	GS10PSQ3065F	SQ3× 65 10pcs.	140×87×7	027900
485643	GS10PSQ3110F	SQ3×110 10pcs.	160×87×7	027917

※Colors inside the table indicate the bit color.

SPQ: 10 sets

Thin Shank "GOSAI" Bit | GS16

● Thin shank model, good for use in a cramped space.

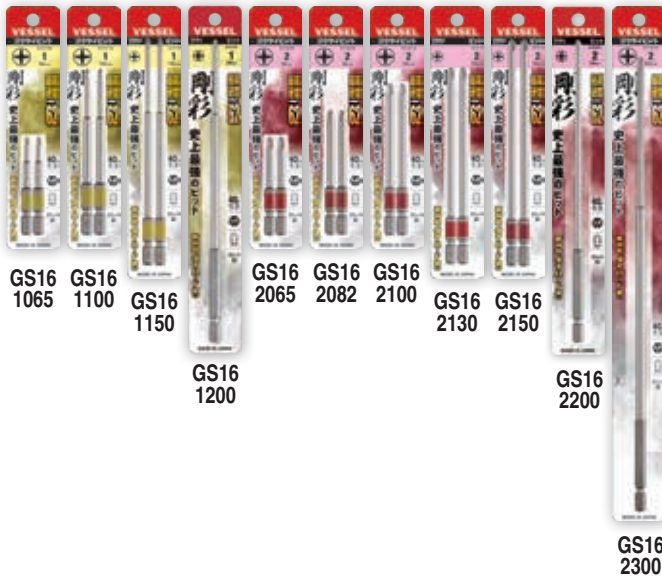
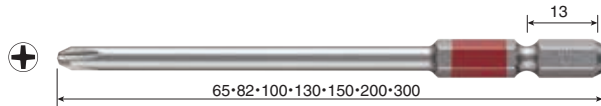

Code No.	Model No.	Set Content	Card size (mm)	JAN (4907587)
485532	GS161065	⊕1 × 65 2pcs.	160×35×8	336323
485533	GS161100	⊕1 ×100 2pcs.	160×35×8	336330
485534	GS161150	⊕1 ×150 2pcs.	180×35×8	336347
485535	GS161200	⊕1 ×200 1pc.	230×35×8	336354
485536	GS162065	⊕2 × 65 2pcs.	160×35×8	336361
485537	GS162082	⊕2 × 82 2pcs.	160×35×8	336378
485538	GS162100	⊕2 ×100 2pcs.	160×35×8	336385
485539	GS162130	⊕2 ×130 2pcs.	180×35×8	336392
485540	GS162150	⊕2 ×150 2pcs.	180×35×8	336408
485541	GS162200	⊕2 ×200 1pc.	230×35×8	336415
485542	GS162300	⊕2 ×300 1pc.	340×35×8	336422

※Colors inside the table indicate the bit color.

SPQ: 10 sets

Thin Shank "GOSAI" Bit, 5-pc set | GS5P



GS5P1065D GS5P2065D GS5P2082D GS5P2100D

GS5P2130D GS5P2150D

Code No.	Model No.	Set Content	Card size (mm)	JAN (4907587)
485636	GS5P1065D	⊕1× 65 5pcs.	160×70×8	006486
485557	GS5P2065D	⊕2× 65 5pcs.	160×70×8	336576
485637	GS5P2082D	⊕2× 82 5pcs.	160×70×8	006493
485558	GS5P2100D	⊕2×100 5pcs.	160×70×8	336583
485559	GS5P2130D	⊕2×130 5pcs.	180×70×8	336590
485560	GS5P2150D	⊕2×150 5pcs.	180×70×8	336606

※Colors inside the table indicate the bit color.

SPQ: 10 sets

Thin Shank "GOSAI" Bit, 10-pc set | GS10P NEW



GS10P2065DF

GS10P2100DF

Code No.	Model No.	Set Content	Package size (mm)	JAN (4907587)
485640	GS10P2065DF	⊕2× 65 10pcs.	140×87×7	027887
485641	GS10P2100DF	⊕2×100 10pcs.	160×87×7	027894

※Colors inside the table indicate the bit color.

SPQ: 10 sets

Precision Type "GOSAI" Bit | GS16



GS16 GS16 GS16 GS16 GS16
00065 00100 0065 0082 0100

Code No.	Model No.	Set Content	Card size (mm)	JAN (4907587)
485527	GS1600065	⊕00× 65 2pcs.	160×35×8	336279
485528	GS1600100	⊕00×100 2pcs.	160×35×8	336286
485529	GS160065	⊕0 × 65 2pcs.	160×35×8	336293
485530	GS160082	⊕0 × 82 2pcs.	160×35×8	336309
485531	GS160100	⊕0 ×100 2pcs.	160×35×8	336316

※Colors inside the table indicate the bit color.

SPQ: 10 sets

HAND TOOLS

INDUSTRIAL BITS

CONSTRUCTION BITS

RECIPROCATING SAW BLADES

ELECTRIC TOOLS

AIR TOOLS

AIR NIPPERS

STATIC SOLUTIONS

GASOLINE ENGINE TOOLS

Slotted "GOSAI" Bit

GS16PL

- For slotted screws.
- Tip width [thickness] is as follows: $\varnothing 1.8$ [0.25], $\varnothing 2.5$ [0.35], $\varnothing 3$ [0.4], $\varnothing 4$ [0.5], $\varnothing 5$ [0.6], $\varnothing 6$ [0.8], $\varnothing 8$ [1.0]

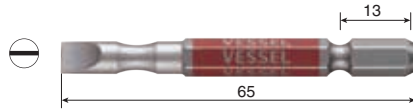

GS16 GS16 GS16 GS16 GS16 GS16 GS16
PL18 PL25 PL30 PL40 PL50 PL60 PL80

Code No.	Model No.	Set Content	Card size (mm)	JAN (4907587)
485543	GS16PL18	$\varnothing 1.8 \times 65$ 2pcs.	135×35× 8	336439
485544	GS16PL25	$\varnothing 2.5 \times 65$ 2pcs.	135×35× 8	336446
485545	GS16PL30	$\varnothing 3 \times 65$ 2pcs.	135×35× 8	336453
485546	GS16PL40	$\varnothing 4 \times 65$ 2pcs.	135×35× 8	336460
485547	GS16PL50	$\varnothing 5 \times 65$ 2pcs.	135×35× 8	336477
485548	GS16PL60	$\varnothing 6 \times 65$ 2pcs.	135×35× 8	336484
485549	GS16PL80	$\varnothing 8 \times 65$ 1pc.	135×35×15	336491

※Colors inside the table indicate the bit color. SPQ: 10 sets

HEX "GOSAI" Bit

GSH

- For hexagon socket head bolts and hexagon socket set screws.

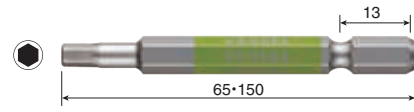

GSH GSH GSH GSH GSH GSH GSH GSH GSH GSH GSH GSH
015S 020S 025S 030S 040S 050S 060S 080S 100S 120S 140S 170S

Code No.	Model No.	Content	Card size (mm)	JAN (4907587)
485567	GSH015S	H 1.5×65 1pc.	135×35× 8	336675
485568	GSH020S	H 2 ×65 1pc.	135×35× 8	336682
485569	GSH025S	H 2.5×65 1pc.	135×35× 8	336699
485570	GSH030S	H 3 ×65 1pc.	135×35× 8	336705
485571	GSH040S	H 4 ×65 1pc.	135×35× 8	336712
485572	GSH050S	H 5 ×65 1pc.	135×35× 8	336729
485573	GSH060S	H 6 ×65 1pc.	135×35× 8	336736
485574	GSH080S	H 8 ×65 1pc.	135×35×10	336743
485575	GSH100S	H 10 ×65 1pc.	135×35×22	336750
485576	GSH120S	H 12 ×65 1pc.	135×35×22	336767
485577	GSH140S	H 14 ×65 1pc.	135×35×22	336774
485578	GSH170S	H 17 ×65 1pc.	135×35×22	336781

※Colors inside the table indicate the bit color. SPQ: 10 sets (GSH100S, GSH120S, GSH140S, GSH170S - SPQ: 5 sets)

Assorted "GOSAI" Bit, 5-pc set

GS5P



GS5P-01 GS5P-02 GS5P-03

Code No.	Model No.	Set Content	Card size (mm)	JAN (4907587)
485563	GS5P-01	Double End $\varnothing 2/\varnothing 6 \times 65$ 1pc.	160×70×8	336637
		Double End $\varnothing 2 \times 110$ 1pc.		
		Double End $\varnothing 3 \times 65$ 1pc.		
		Thin shank $\varnothing 1 \times 65$ 1pc.		
		Thin shank $\varnothing 2 \times 100$ 1pc.		
485562	GS5P-02	Double End $\varnothing 1 \times 65$ 1pc.	160×70×8	336620
		Double End $\varnothing 2 \times 65$ 1pc.		
		Double End $\varnothing 2 \times 110$ 2pcs.		
		Double End $\varnothing 3 \times 65$ 1pc.		
485561	GS5P-03	Thin shank $\varnothing 00 \times 65$ 1pc.	160×70×8	336613
		Thin shank $\varnothing 0 \times 65$ 1pc.		
		Thin shank $\varnothing 1 \times 65$ 1pc.		
		Thin shank $\varnothing 3 \times 65$ 1pc.		
		Thin shank $\varnothing 4 \times 65$ 1pc.		
		Thin shank $\varnothing 4 \times 65$ 1pc.		

※Colors inside the table indicate the bit color. SPQ: 10 sets

HEX "GOSAI" Bit, Long type

GSH



GSH GSH GSH GSH GSH GSH GSH
020L 025L 030L 040L 050L 060L 080L

Code No.	Model No.	Content	Card size (mm)	JAN (4907587)
485580	GSH020L	H 2 ×150 1pc.	180×35× 8	336804
485581	GSH025L	H 2.5×150 1pc.	180×35× 8	336811
485582	GSH030L	H 3 ×150 1pc.	180×35× 8	336828
485583	GSH040L	H 4 ×150 1pc.	180×35× 8	336835
485584	GSH050L	H 5 ×150 1pc.	180×35× 8	336842
485585	GSH060L	H 6 ×150 1pc.	180×35× 8	336859
485586	GSH080L	H 8 ×150 1pc.	180×35×15	336866

※Colors inside the table indicate the bit color. SPQ: 10 sets

Assorted HEX "GOSAI" Bit, 5-pc set | GS5P



GS5P-31 GS5P-32



Code No.	Model No.	Set Content	Card size (mm)	JAN (4907587)
485579	GS5P-31	H 2.5× 65 1pc.	160×70×8	336798
		H 3 × 65 1pc.		
		H 4 × 65 1pc.		
		H 5 × 65 1pc.		
		H 6 × 65 1pc.		
485587	GS5P-32	H 2.5×150 1pc.	180×70×8	336873
		H 3 ×150 1pc.		
		H 4 ×150 1pc.		
		H 5 ×150 1pc.		

※Colors inside the table indicate the bit color.

SPQ: 10 sets

TORX® "GOSAI" Bit | GSVT

- For TORX® screws.
- Manufactured under the license of TORX. Supports any TORX® screws.
- Supports tamper-proof screws (except T4 and T5).



GSVT 04S GSVT 05S GSVT 06SH GSVT 08SH GSVT 10SH GSVT 15SH GSVT 20SH GSVT 25SH GSVT 27SH GSVT 30SH GSVT 40SH

Code No.	Model No.	Content	Card size (mm)	JAN (4907587)
485603	GSVT04S	T4 × 65 1pc.	135×35×8	337030
485604	GSVT05S	T5 × 65 1pc.	135×35×8	337047
485605	GSVT06SH	T6H × 65 1pc.	135×35×8	337054
485606	GSVT08SH	T8H × 65 1pc.	135×35×8	337061
485607	GSVT10SH	T10H× 65 1pc.	135×35×8	337078
485608	GSVT15SH	T15H× 65 1pc.	135×35×8	337085
485609	GSVT20SH	T20H× 65 1pc.	135×35×8	337092
485610	GSVT25SH	T25H× 65 1pc.	135×35×8	337108
485611	GSVT27SH	T27H× 65 1pc.	135×35×8	337115
485612	GSVT30SH	T30H× 65 1pc.	135×35×8	337122
485613	GSVT40SH	T40H× 65 1pc.	135×35×8	337139

※Colors inside the table indicate the bit color.

SPQ: 10 sets

TORX® "GOSAI" Bit, Long type | GSVT



GSVT 10LH GSVT 15LH GSVT 20LH GSVT 25LH GSVT 27LH GSVT 30LH GSVT 40LH



Code No.	Model No.	Content	Card size (mm)	JAN (4907587)
485615	GSVT10LH	T10H×150 1pc.	180×35×8	337153
485616	GSVT15LH	T15H×150 1pc.	180×35×8	337160
485617	GSVT20LH	T20H×150 1pc.	180×35×8	337177
485618	GSVT25LH	T25H×150 1pc.	180×35×8	337184
485619	GSVT27LH	T27H×150 1pc.	180×35×8	337191
485620	GSVT30LH	T30H×150 1pc.	180×35×8	337207
485621	GSVT40LH	T40H×150 1pc.	180×35×8	337214

※Colors inside the table indicate the bit color.

SPQ: 10 sets

TORX® is a registered trademark of Acument Intellectual Properties, LLC (USA). VESSEL is an official licensee of Acument Intellectual Properties, LLC.

Assorted TORX® "GOSAI" Bit, 5-pc set | GS5P



GS5P-33 GS5P-34



Code No.	Model No.	Set Content	Card size (mm)	JAN (4907587)
485614	GS5P-33	T10H× 65 1pc.	160×70×8	337146
		T15H× 65 1pc.		
		T20H× 65 1pc.		
		T25H× 65 1pc.		
		T30H× 65 1pc.		
485622	GS5P-34	T10H×150 1pc.	180×70×8	337221
		T15H×150 1pc.		
		T20H×150 1pc.		
		T25H×150 1pc.		

※Colors inside the table indicate the bit color.

SPQ: 10 sets

HAND TOOLS

INDUSTRIAL BITS

CONSTRUCTION BITS

RECIPROCATING SAW BLADES

ELECTRIC TOOLS

AIR TOOLS

AIR NIPPERS

STATIC SOLUTIONS

GASOLINE ENGINE TOOLS

Ball Point "GOSAI" Bit

GSBP

- For hexagon socket head bolts and hexagon socket set screws.
- Ball-point shape tip-end. Can tilt 26°. Suitable for use in a cramped and limited space.

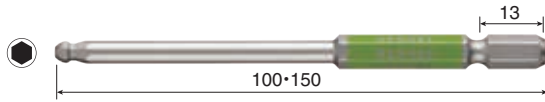

GSBP 020S GSBP 025S GSBP 030S GSBP 040S GSBP 050S GSBP 060S GSBP 080S GSBP 100S

Code No.	Model No.	Content	Card size (mm)	JAN (4907587)
485588	GSBP020S	H 2 ×100 1pc.	160×35× 8	336880
485589	GSBP025S	H 2.5×100 1pc.	160×35× 8	336897
485590	GSBP030S	H 3 ×100 1pc.	160×35× 8	336903
485591	GSBP040S	H 4 ×100 1pc.	160×35× 8	336910
485592	GSBP050S	H 5 ×100 1pc.	160×35× 8	336927
485593	GSBP060S	H 6 ×100 1pc.	160×35× 8	336934
485594	GSBP080S	H 8 ×100 1pc.	160×35×15	336941
485595	GSBP100S	H 10 ×100 1pc.	160×35×22	336958

※Colors inside the table indicate the bit color.

SPQ: 10 sets

Ball Point "GOSAI" Bit, Long type | GSBP



GSBP 030L GSBP 040L GSBP 050L GSBP 060L GSBP 080L

Code No.	Model No.	Content	Card size (mm)	JAN (4907587)
485597	GSBP030L	H 3 ×150 1pc.	180×35× 8	336972
485598	GSBP040L	H 4 ×150 1pc.	180×35× 8	336989
485599	GSBP050L	H 5 ×150 1pc.	180×35× 8	336996
485600	GSBP060L	H 6 ×150 1pc.	180×35× 8	337009
485601	GSBP080L	H 8 ×150 1pc.	180×35×15	337016

※Colors inside the table indicate the bit color.

SPQ: 10 sets

Assorted Ball Point "GOSAI" Bit, 5-pc set

GS5P



GS5P-35 GS5P-36

Code No.	Model No.	Set Content	Card size (mm)	JAN (4907587)
485596	GS5P-35	H 3 ×100 1pc.	160×70×15	336965
		H 4 ×100 1pc.		
		H 5 ×100 1pc.		
		H 6 ×100 1pc.		
		H 8 ×100 1pc.		
485602	GS5P-36	H 3 ×150 1pc.	180×70×15	337023
		H 4 ×150 1pc.		
		H 5 ×150 1pc.		
		H 6 ×150 1pc.		
		H 8 ×150 1pc.		

※Colors inside the table indicate the bit color.

SPQ: 10 sets

"GOSAI" Bit w/Tube | GSC

GSC

- Slim shank type, with tube, not damaging the terminal block.



GSC 161100 GSC 161150 GSC 162100 GSC 162150 GSC 163100 GSC 163150 GSC 16PL60

Code No.	Model No.	Set Content	Card size (mm)	JAN (4907587)
485701	GSC161100	⊕1×100 1pc.	160×35×8	015846
485702	GSC161150	⊕1×150 1pc.	180×35×8	015853
485703	GSC162100	⊕2×100 1pc.	160×35×8	015860
485704	GSC162150	⊕2×150 1pc.	180×35×8	015877
485706	GSC163100	⊕3×100 1pc.	160×35×8	015891
485707	GSC163150	⊕3×150 1pc.	180×35×8	015907
485708	GSC16PL60	⊖6×100 1pc.	160×35×8	015914

※Colors inside the table indicate the bit color.

SPQ: 10 sets

HAND TOOLS

INDUSTRIAL BITS

CONSTRUCTION BITS

RECIPROCATING SAW BLADES

ELECTRIC TOOLS

AIR TOOLS

AIR NIPPERS

STATIC SOLUTIONS

GASOLINE ENGINE TOOLS

DC/DZ/DS/DRB

Problem Solving Bits

Professional satisfying quality in the era of 40V power tools!

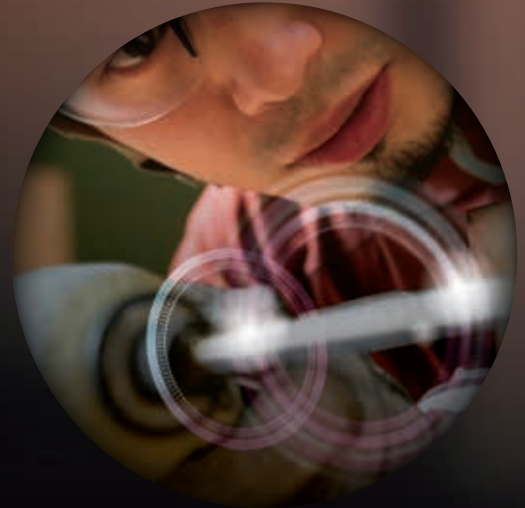

Extra Superalloy

Extra Superalloy features "toughness" and "hardness", corresponding to the power and speed of electric impact drivers. Max hardness of 62HRC. Not only resistant to breakage or bending, but also transmits torque accurately and reliably, allowing screws to be tightened securely.

DC14/DC16

Cushion Bit

Tighten a screw perfectly without center run-out or in a cramped space. Cushion ring reduces the run-out of the bit.

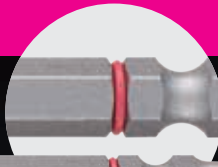

For fixing wedges on the stairs or putting up curtain rails.



Use the thin shank type for cramped spaces!

DZ14/DZ16

Zigzag Bit

Prevent the screw from being stripped, when tightening screws on unstable items or from a diagonal angle. The zigzag shaped tip bites into the screw head.



For fixing studs and installing handrails.



For unstable items!

DS14

Slender Bit

Screw head is well seen, when small head screws are tightened or the screw head should be below the workpiece. Slim tip-end helps to see well the screw head, even if it is a slim screw.



For fastening works with concrete panels and tightening mini screws for floor construction.

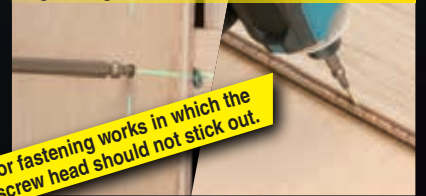

For fastening works in which the screw head should not stick out.

DRB14/DRB16

Rib Bit

Resistant to hard screws, when fastening hard workpieces or doing the repeated work. "Tip-end with ribs", resistant to twisting and breakage.



For the ALC member attachment to the light-gauge steel, and the siding board attachment.



High durability even with drilling screws!

HAND TOOLS

INDUSTRIAL BITS

CONSTRUCTION BITS

RECIPROCATING SAW BLADES

ELECTRIC TOOLS

AIR TOOLS

AIR NIPPERS

STATIC SOLUTIONS

GASOLINE ENGINE TOOLS

HAND TOOLS

INDUSTRIAL BITS

CONSTRUCTION BITS

RECIPROCATING SAW BLADES

ELECTRIC TOOLS

AIR TOOLS

AIR NIPPERS

STATIC SOLUTIONS

GASOLINE ENGINE TOOLS

Double-End Cushion Bit

DC14 NEW

- Cushion ring reduces the runout of the bit.
- Optimal for work in cramped spaces or for the applications that the screw should be tightened straight.
- Extra Superalloy material enhances strength and toughness.

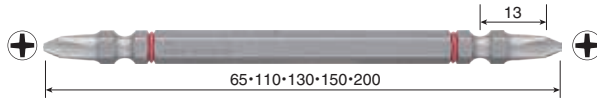

DC14 1065 DC14 1110 DC14 2065 DC14 2110 DC14 2130 DC14 2150

Code No.	Model No.	Content	Card size (mm)	JAN (4907587)
485711	DC141065	⊕1× 65 2pcs.	160×35×8	029201
485712	DC141110	⊕1×110 2pcs.	160×35×8	029218
485713	DC142065	⊕2× 65 2pcs.	160×35×8	029225
485714	DC142110	⊕2×110 2pcs.	160×35×8	029232
485715	DC142130	⊕2×130 2pcs.	180×35×8	029249
485716	DC142150	⊕2×150 2pcs.	180×35×8	029256
485717	DC142200	⊕2×200 1pc.	230×35×8	029263

SPQ: 10 sets

Double-End Slender Bit

DS14 NEW

- Slim tip-end is good for slim screws.
- For tightening small head screws or when they should be below the workpiece.
- Extra Superalloy material enhances strength and toughness.

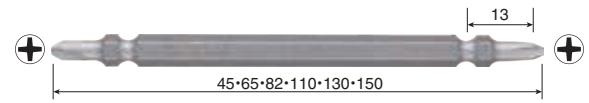

DS14 1065 DS14 1110 DS14 2045 DS14 2065 DS14 2082 DS14 2110 DS14 2130 DS14 2150

Code No.	Model No.	Content	Card size (mm)	JAN (4907587)
485742	DS141065	⊕1× 65 2pcs.	160×35×8	029515
485743	DS141110	⊕1×110 2pcs.	160×35×8	029522
485744	DS142045	⊕2× 45 2pcs.	160×35×8	029539
485745	DS142065	⊕2× 65 2pcs.	160×35×8	029546
485746	DS142082	⊕2× 82 2pcs.	160×35×8	029553
485747	DS142110	⊕2×110 2pcs.	160×35×8	029560
485748	DS142130	⊕2×130 2pcs.	180×35×8	029577
485749	DS142150	⊕2×150 2pcs.	180×35×8	029584

SPQ: 10 sets

Thin Shank Cushion Bit

DC16 NEW

- Thin shank allows for use in cramped spaces.

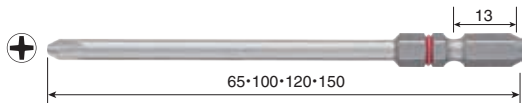

DC16 1065 DC16 1100 DC16 2065 DC16 2100 DC16 2120 DC16 2150

Code No.	Model No.	Content	Card size (mm)	JAN (4907587)
485718	DC161065	⊕1× 65 2pcs.	160×35×8	029270
485719	DC161100	⊕1×100 2pcs.	160×35×8	029287
485720	DC162065	⊕2× 65 2pcs.	160×35×8	029294
485721	DC162100	⊕2×100 2pcs.	160×35×8	029300
485722	DC162120	⊕2×120 2pcs.	180×35×8	029317
485723	DC162150	⊕2×150 2pcs.	180×35×8	029324

SPQ: 10 sets

Double-End Slender Bit, 5-pc set

DS5P NEW



DS5P2065 DS5P2082 DS5P2110

Code No.	Model No.	Content	Card size (mm)	JAN (4907587)
485750	DS5P2065	⊕2× 65 5pcs.	160×70×8	029591
485751	DS5P2082	⊕2× 82 5pcs.	160×70×8	029607
485752	DS5P2110	⊕2×110 5pcs.	160×70×8	029614

SPQ: 10 sets

Double-End Slender Bit, 10-pc set

DS10P NEW



DS10P 2065F DS10P 2110F

Code No.	Model No.	Content	Package size (mm)	JAN (4907587)
485764	DS10P2065F	⊕2× 65 10pcs.	140×87×7.3	030436
485765	DS10P2110F	⊕2×110 10pcs.	160×87×7.3	030443

SPQ: 10 sets

Cushion Bit, 5-pc set

DC5P NEW



DC5P 2065 DC5P 2110 DC5P 2065D DC5P 2100D

Code No.	Model No.	Content	Card size (mm)	JAN (4907587)
485724	DC5P2065	⊕2× 65 5pcs.	160×70×8	029331
485725	DC5P2110	⊕2×110 5pcs.	160×70×8	029348
485726	DC5P2065D	⊕2× 65 5pcs.	160×70×8	029355
485727	DC5P2100D	⊕2×100 5pcs.	160×70×8	029362

SPQ: 10 sets

Double-End Zigzag Bit

DZ14 NEW

- Zigzag shaped tip-end prevents the cam-out of the bit.
- Can tighten screws even in the poorly scaffolded area or in an unstable place.
- Extra Superalloy material enhances strength and toughness.

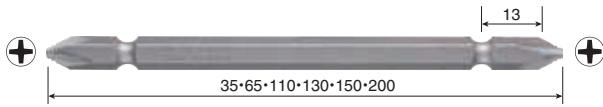

Code No.	Model No.	Content	Card size (mm)	JAN (4907587)
485728	DZ142035	⊕2× 35 2pcs.	160×35×8	029379
485729	DZ142065	⊕2× 65 2pcs.	160×35×8	029386
485730	DZ142110	⊕2× 110 2pcs.	160×35×8	029393
485731	DZ142130	⊕2× 130 2pcs.	180×35×8	029409
485732	DZ142150	⊕2× 150 2pcs.	180×35×8	029416
485733	DZ142200	⊕2× 200 1pc.	230×35×8	029423

SPQ: 10 sets

Thin Shank Zigzag Bit

DZ16 NEW

- Thin shank allows for use in cramped spaces.

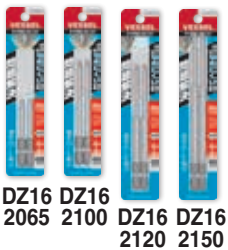
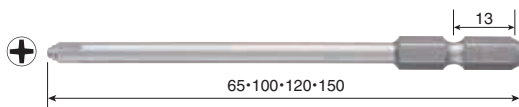

Code No.	Model No.	Content	Card size (mm)	JAN (4907587)
485734	DZ162065	⊕2× 65 2pcs.	160×35×8	029430
485735	DZ162100	⊕2× 100 2pcs.	160×35×8	029447
485736	DZ162120	⊕2× 120 2pcs.	180×35×8	029454
485737	DZ162150	⊕2× 150 2pcs.	180×35×8	029461

SPQ: 10 sets

Zigzag Bit, 5-pc set

DZ5P NEW

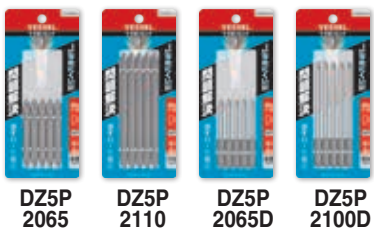

Code No.	Model No.	Content	Card size (mm)	JAN (4907587)
485738	DZ5P2065	⊕2× 65 5pcs.	160×70×8	029478
485739	DZ5P2110	⊕2× 110 5pcs.	160×70×8	029485
485740	DZ5P2065D	⊕2× 65 5pcs.	160×70×8	029492
485741	DZ5P2100D	⊕2× 100 5pcs.	160×70×8	029508

SPQ: 10 sets

Double-End Rib Bit

DRB14 NEW

- The special tip-end with ribs is resistant to breakage and bending. Long life.
- Good for fastening hard workpieces or doing the repeated work.
- Extra Superalloy material enhances strength and toughness.

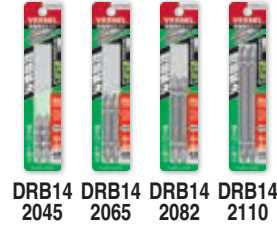
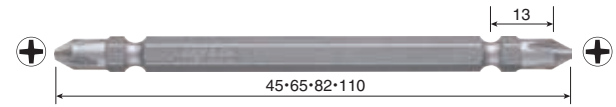

Code No.	Model No.	Content	Card size (mm)	JAN (4907587)
485753	DRB142045	⊕2× 45 2pcs.	160×35×8	029621
485754	DRB142065	⊕2× 65 2pcs.	160×35×8	029638
485755	DRB142082	⊕2× 82 2pcs.	160×35×8	029645
485756	DRB142110	⊕2× 110 2pcs.	160×35×8	029652

SPQ: 10 sets

Thin Shank Rib Bit

DRB16 NEW

- Thin shank allows for use in cramped spaces.

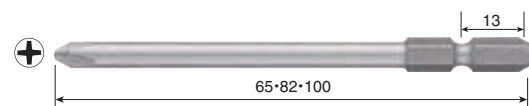

Code No.	Model No.	Content	Card size (mm)	JAN (4907587)
485757	DRB162065	⊕2× 65 2pcs.	160×35×8	029669
485758	DRB162082	⊕2× 82 2pcs.	160×35×8	029676
485759	DRB162100	⊕2× 100 2pcs.	160×35×8	029683

SPQ: 10 sets

Double-End Rib Bit, 5-pc set

DRB5P NEW



Code No.	Model No.	Content	Card size (mm)	JAN (4907587)
485760	DRB5P2045	⊕2× 45 5pcs.	160×70×8	029690
485761	DRB5P2065	⊕2× 65 5pcs.	160×70×8	029706
485762	DRB5P2082	⊕2× 82 5pcs.	160×70×8	029720
485763	DRB5P2110	⊕2× 110 5pcs.	160×70×8	029737

SPQ: 10 sets

SST
 "SAKISUBO" Torsion Bit
 SDT
 "SAKISUBO" Slim Torsion Bit



Very popular "SAKISUBO" series



SST

SDT

SST
 "SAKISUBO" Torsion Bit

Highly durable bit with torsion effect added to the SAKISUBO bit. The cushioning effect of the constricted part prevents the bit from bouncing, for efficient work. Magnetized.

SDT
 "SAKISUBO" Slim Torsion Bit

Uses a new material, Extra Superalloy, with different strength and toughness! The bit material with both hardness and toughness makes the bit hard to break. Also, the tapered tip-end makes it easier to see screw heads. Magnetized.



※Image is for illustration purposes.

HAND TOOLS
 INDUSTRIAL BITS
 CONSTRUCTION BITS
 RECIPROCATING SAW BLADES
 ELECTRIC TOOLS
 AIR TOOLS
 AIR NIPPERS
 STATIC SOLUTIONS
 GASOLINE ENGINE TOOLS

"SAKISUBO" Torsion Bit, 2-pc set | SST

- Highly durable tapered bit combined with torsion effect.
- Cushion effect at the constricted part prevents cam-out, improving working efficiency.

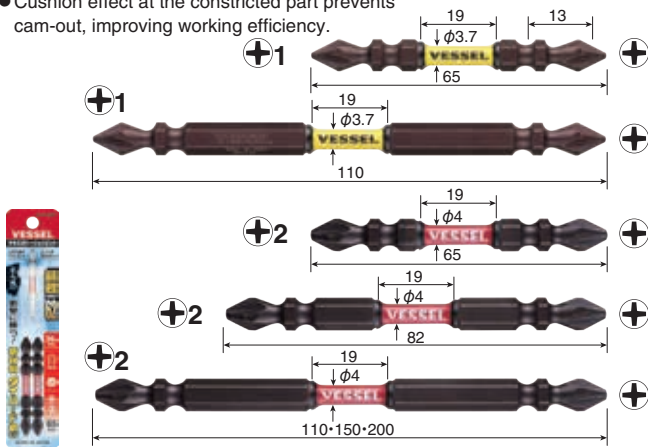

Code No.	Model No.	Contents	Card size (mm)	JAN (4907587)
485321	SST141065	⊕1×φ3.7× 65 2pcs.	160×35×8	349675
485335	SST141110	⊕1×φ3.7×110 2pcs.	160×35×8	350404
485322	SST142065	⊕2×φ4 × 65 2pcs.	160×35×8	349682
485323	SST142082	⊕2×φ4 × 82 2pcs.	160×35×8	349699
485324	SST142110	⊕2×φ4 ×110 2pcs.	160×35×8	349705
485325	SST142150	⊕2×φ4 ×150 2pcs.	180×35×8	349712
485326	SST142200	⊕2×φ4 ×200 2pcs.	260×35×8	349729

SPQ: 10 sets

"SAKISUBO" Torsion Bit, 5-pc set | SST5P



Code No.	Model No.	Contents	Card size (mm)	JAN (4907587)
485444	SST5P2065	⊕2×φ4 × 65 5pcs.	160×70×8	349736
485445	SST5P2082	⊕2×φ4 × 82 5pcs.	160×70×8	349743
485446	SST5P2110	⊕2×φ4 ×110 5pcs.	160×70×8	349750

SPQ: 10 sets

"SAKISUBO" Torsion Bit, 10-pc set | SST10P



Code No.	Model No.	Contents	Package size (mm)	JAN (4907587)
485451	SST10P2065F	⊕2× 65 10pcs.	143×87×7	345431
485452	SST10P2082F	⊕2× 82 10pcs.	143×87×7	345448
485453	SST10P2110F	⊕2×110 10pcs.	162×87×7	345455

SPQ: 10 sets

Recessed "SAKISUBO" Bit, 2-pc set | SS16

- Thin shank type ideal for working in narrow places.
- Cushion effect at the constricted part prevents cam-out that may occur when the screw passes through wood grains in the wooden work.

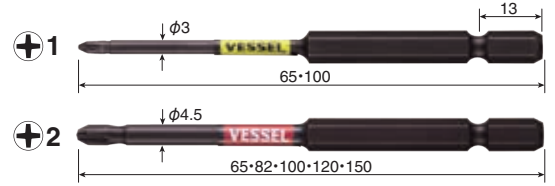

Code No.	Model No.	Contents	Card size (mm)	JAN (4907587)
485336	SS161065	⊕1×φ3 × 65 2pcs.	160×35×8	347411
485327	SS161100	⊕1×φ3 ×100 2pcs.	160×35×8	349767
485337	SS162065	⊕2×φ4.5× 65 2pcs.	160×35×8	347428
485338	SS162082	⊕2×φ4.5× 82 2pcs.	160×35×8	347435
485328	SS162100	⊕2×φ4.5×100 2pcs.	160×35×8	349774
485339	SS162120	⊕2×φ4.5×120 2pcs.	180×35×8	347442
485340	SS162150	⊕2×φ4.5×150 2pcs.	180×35×8	347459

SPQ: 10 sets

Recessed "SAKISUBO" Hex Bit | SS16H

- For hex hole bolts and screws.
- Long type useful for hard-to-reach places.



Code No.	Model No.	Contents	Card size (mm)	JAN (4907587)
485329	SS16H2010	H2.0 × 100 1pc.	160×35×8	349781
485330	SS16H2510	H2.5 × 100 1pc.	160×35×8	349798
485331	SS16H3010	H3.0 × 100 1pc.	160×35×8	349804
485332	SS16H4010	H4.0 × 100 1pc.	160×35×8	349811
485333	SS16H5010	H5.0 × 100 1pc.	160×35×8	349828
485334	SS16H6010	H6.0 × 100 1pc.	160×35×8	349835

SPQ: 10 sets

Recessed "SAKISUBO" Hex Bit, 5-pc set | BW-32



Code No.	Model No.	Contents	Card size (mm)	JAN (4907587)
486592	BW-32	Recessed "SAKISUBO" Hex Bit H2.5, 3.0, 4.0, 5.0, 6.0 × 100 1pc. each Magnetic Catcher 1pc.	160×70×23	350466

SPQ: 10 sets

HAND TOOLS

INDUSTRIAL BITS

Recessed "SAKISUBO" Ball Point Bit | SS16BP

- For hex hole bolt and screw.
 - Ball point tip that can tilt 30°.
- Suitable for working in cramped places of high-density packaging.



Code No.	Model No.	Contents	Card size (mm)	JAN (4907587)
485341	SS16BP2010	H 2.0 × 100 1pc.	160×35×8	349842
485342	SS16BP2510	H 2.5 × 100 1pc.	160×35×8	349859
485343	SS16BP3010	H 3.0 × 100 1pc.	160×35×8	349866
485344	SS16BP4010	H 4.0 × 100 1pc.	160×35×8	349873
485345	SS16BP5010	H 5.0 × 100 1pc.	160×35×8	349880
485346	SS16BP6010	H 6.0 × 100 1pc.	160×35×8	349897

SPQ: 10 sets

Recessed "SAKISUBO" TORX® Bit | SS16T

- Specialized for TORX® screws.
- Manufactured under license by TORX, this bit is compatible with any TORX® screws.



Code No.	Model No.	Contents	Card size (mm)	JAN (4907587)
485347	SS16T1010	T10 × 100 1pc.	160×35×8	349903
485348	SS16T1510	T15 × 100 1pc.	160×35×8	349910
485349	SS16T2010	T20 × 100 1pc.	160×35×8	349927
485350	SS16T2510	T25 × 100 1pc.	160×35×8	349934
485351	SS16T3010	T30 × 100 1pc.	160×35×8	349941

SPQ: 10 sets

Recessed "SAKISUBO" TORX® Bit, 5-pc set | BW-33



Code No.	Model No.	Contents	Card size (mm)	JAN (4907587)
486593	BW-33	Recessed "SAKISUBO" TORX® Bit T10, 15, 20, 25, 30 × 100 1pc. each Magnetic Catcher 1pc.	160×70×23	350473

TORX® is a registered trademark of Acument Intellectual Properties, LLC (USA).
VESSEL is an official licensee of Acument Intellectual Properties, LLC.

SPQ: 10 sets

Recessed "SAKISUBO" Bit w/Magnetic Catcher | NMCS

- Magnetic catcher with two neodymium magnets helps catch screws securely.
- Combined with recessed bit, ideal for continuous screw tightening in confined places and on the dry walls.

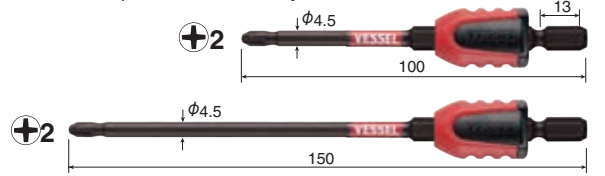

Code No.	Model No.	Contents	Card size (mm)	JAN (4907587)
485354	NMCS16210	Recessed "SAKISUBO" Bit $\Phi 2 \times \Phi 4.5 \times 100$ 1pc. Magnetic Catcher 1pc.	160×35×17	349958
485355	NMCS16215	Recessed "SAKISUBO" Bit $\Phi 2 \times \Phi 4.5 \times 150$ 1pc. Magnetic Catcher 1pc.	210×35×17	349965

SPQ: 10 sets

Magnetic Catcher | NMC

- Magnetic catcher with two built-in neodymium magnets helps catch screws securely.
- Can perform continuous screw tightening in cramped and limited spaces or drywalling, in combination with a bit.

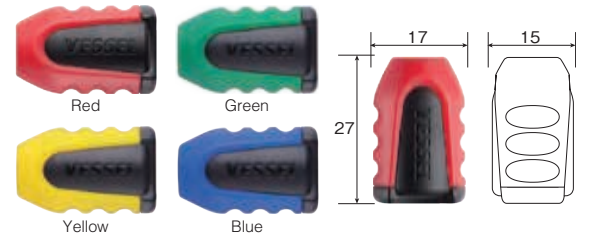

2-pc set (w/cardboard)

Code No.	Model No.	Contents	Card size (mm)	SPQ	Outer Ctn. (sets)	JAN (4907587)
486575	NMC-2P	Red 2-pc set	120×44×20	10	60	347251
486771	NMC-2PG	Green 2-pc set	120×44×20	10	60	015594
486772	NMC-2PY	Yellow 2-pc set	120×44×20	10	60	015600
486773	NMC-2PB	Blue 2-pc set	120×44×20	10	60	015617

10 pcs (in a box)

Code No.	Model No.	Contents	Package size (mm)	SPQ	Outer Ctn. (sets)	JAN (4907587)
486778	NMC-1PR	Red	80×58×55	10	120	015716
486775	NMC-1PG	Green	80×58×55	10	120	015686
486776	NMC-1PY	Yellow	80×58×55	10	120	015693
486777	NMC-1PB	Blue	80×58×55	10	120	015709

Magnetic Catcher Short | NMS NEW

- Movable magnets allow to be used with thin shank screwdrivers and bits (minimum $\Phi 4$).
- Bits and screwdrivers can be strongly magnetized when this is attached.
- Strong magnet can firmly catch long coarse thread screws, too.



Code No.	Model No.	Contents	Card size (mm)	JAN (4907587)
486779	NMS-2PR	Red 2-pc set	120×44×20	028211
486780	NMS-2PG	Green 2-pc set	120×44×20	028228
486781	NMS-2PY	Yellow 2-pc set	120×44×20	028235
486782	NMS-2PB	Blue 2-pc set	120×44×20	028242

SPQ: 10 sets

CONSTRUCTION BITS

RECIPROCATING SAW BLADES

ELECTRIC TOOLS

AIR TOOLS

AIR NIPPERS

STATIC SOLUTIONS

GASOLINE ENGINE TOOLS

ONE POINT INMC

Strong magnet catches screws.
Magnetic Catcher

Approx. **20**
times stronger
0.318kgf

Magnetized bits lose their magnetic force due to heat and impact during work. For example, after tightening several dozen of wood screws, the magnetic force went down by 46%.

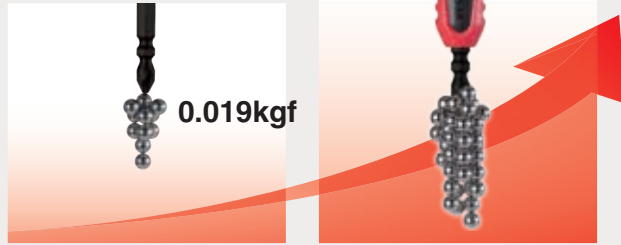

"SAKISUBO" Bit w/Magnetic Catcher (plastic bag), 3-pc set INMCS3P

- A set of "SAKISUBO" bits with a convenient magnetizer.
- Each 3-pc and 8-pc sets comes with 1pc of Magnetic Catcher.

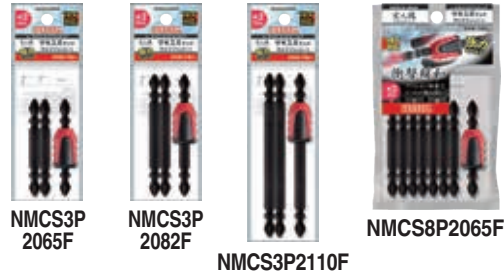

Code No.	Model No.	Contents	Package size (mm)	JAN (4907587)
485359	NMCS3P2065F	"SAKISUBO" Bit $\varnothing 2 \times 65$ 3pcs. Magnetic Catcher 1pc.	130×50×16	349972
485360	NMCS3P2082F	"SAKISUBO" Bit $\varnothing 2 \times 82$ 3pcs. Magnetic Catcher 1pc.	130×50×16	349989
485361	NMCS3P2110F	"SAKISUBO" Bit $\varnothing 2 \times 110$ 3pcs. Magnetic Catcher 1pc.	160×50×16	349996

SPQ: 10 sets

Double End "SAKISUBO" Bit, 2-pc set IS14

- The constricted part acts as a cushion, absorbing the shock from power impact tools, and improves durability.
- Optimal for fastening joists, staircase construction, concrete panels, sash attachment and interior fixtures.

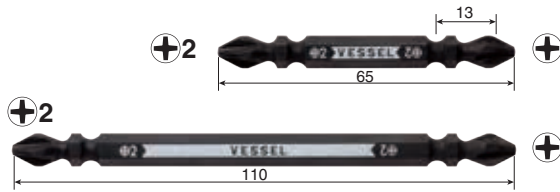

"SAKISUBO" Bit w/Magnetic Catcher (plastic bag), 8-pc set INMCS8P

Code No.	Model No.	Contents	Package size (mm)	JAN (4907587)
485362	NMCS8P2065F	"SAKISUBO" Bit $\varnothing 2 \times 65$ 8pcs. Magnetic Catcher 1pc.	143×87×16	350282

SPQ: 10 sets

Double End Power Bit (w/Bit Belt) VBA

- Holder included for hanging from the waist belt.
- Anti-rust surface treatment.
- Popular 2 sizes available.



Code No.	Model No.	Contents	Card size (mm)	JAN (4907587)
485447	S142065	$\varnothing 2 \times 65$ 2pcs.	160×35×8	347213
485448	S142082	$\varnothing 2 \times 82$ 2pcs.	160×35×8	347220
485449	S142110	$\varnothing 2 \times 110$ 2pcs.	160×35×8	347237
485450	S142150	$\varnothing 2 \times 150$ 2pcs.	210×35×8	347244

SPQ: 10 sets

Double End "SAKISUBO" Bit, 5-pc set IS5P

- Tapered tip prevents cam-out.
- Excellent durability.



Code No.	Model No.	Contents	Card size (mm)	JAN (4907587)
484056	VBA20651	Non-electrolytic plated bit $\varnothing 2 \times 65$ mm 10pcs.	53×100×111	353078
484057	VBA21101	Non-electrolytic plated bit $\varnothing 2 \times 110$ mm 10pcs.	53×100×153	353085

Comes with one bit holder. SPQ: 10 sets

Code No.	Model No.	Contents	Package size (mm)	JAN (4907587)
485435	S5P2065F	$\varnothing 2 \times 65$ 5pcs.	135×50×7	347176
485436	S5P2110F	$\varnothing 2 \times 110$ 5pcs.	160×50×7	347183

SPQ: 10 sets

HAND TOOLS

INDUSTRIAL BITS

CONSTRUCTION BITS

RECIPROCATING SAW BLADES

ELECTRIC TOOLS

AIR TOOLS

AIR NIPPERS

STATIC SOLUTIONS

GASOLINE ENGINE TOOLS

"SAKISUBO" Slim Torsion Bit, 2-pc set
I SDT

- Different strength and toughness because of highest hardness of 62HRC special steel.
- Double torsion effect of <shock mitigation x shock absorption>.
- Slim shape tip-end makes screw heads easier to see by far.

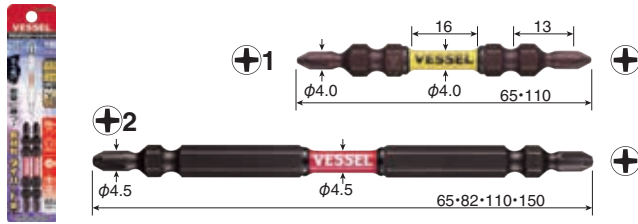

Code No.	Model No.	Contents	Card size (mm)	JAN (4907587)
485403	SDT141065	⊕1×φ4.0× 65 2pcs.	160×35×8	347527
485404	SDT141110	⊕1×φ4.0×110 2pcs.	160×35×8	347534
485395	SDT142065	⊕2×φ4.5× 65 2pcs.	160×35×8	347466
485396	SDT142082	⊕2×φ4.5× 82 2pcs.	160×35×8	347473
485397	SDT142110	⊕2×φ4.5×110 2pcs.	160×35×8	347480
485405	SDT142150	⊕2×φ4.5×150 2pcs.	180×35×8	347541

SPQ: 10 sets

"SAKISUBO" Slim Torsion Bit, 5-pc set
I SDT5P



Code No.	Model No.	Contents	Card size (mm)	JAN (4907587)
485398	SDT5P2065	⊕2×φ4.5× 65 5pcs.	160×70×8	347497
485399	SDT5P2082	⊕2×φ4.5× 82 5pcs.	160×70×8	347503
485400	SDT5P2110	⊕2×φ4.5×110 5pcs.	160×70×8	347510

SPQ: 10 sets

"SAKISUBO" Slim Torsion Bit, 10-pc set
I SDT10P



Code No.	Model No.	Contents	Package size (mm)	JAN (4907587)
485457	SDT10P2065F	⊕2× 65 10pcs.	143×87×7	011626
485458	SDT10P2082F	⊕2× 82 10pcs.	143×87×7	011633
485459	SDT10P2110F	⊕2×110 10pcs.	162×87×7	011640

SPQ: 10 sets

ONE POINT I SDT I SST
Resistant to breakage and bending. Securely tightened.
New material Extra Superalloy!!

Supporting the higher speeds and torques of electric impact drivers...our answer lies in the development of a new tough material.
[Extra Superalloy] A bit material that does not lose to impact.

Impeccable strength and toughness!

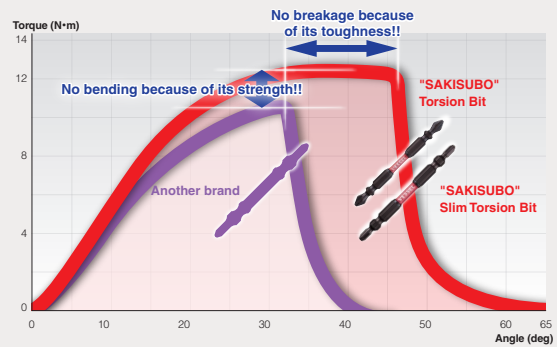

"SAKISUBO" Slim Torsion Bit is ...

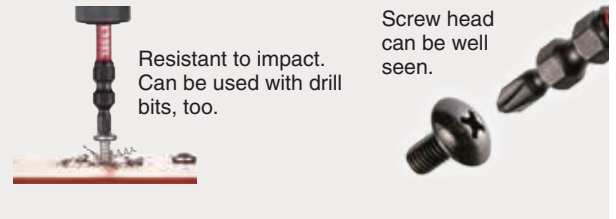

Recessed Plus-Minus Bit I PS

- Dedicated to plus-minus screws.
- With a tube for prevention of short circuit accidents.



Code No.	Model No.	Contents	Card size (mm)	JAN (4907587)
485411	PS161110	PS1×φ4 ×φ4.5×110 1pc.	160×35×8	347114
485412	PS162110	PS2×φ5.5×φ6 ×110 1pc.	160×35×8	347121
485413	PS162150	PS2×φ5.5×φ6 ×150 1pc.	210×35×8	347138

SPQ: 10 sets

HAND TOOLS

INDUSTRIAL BITS

CONSTRUCTION BITS

RECIPROCATING SAW BLADES

ELECTRIC TOOLS

AIR TOOLS

AIR NIPPERS

STATIC SOLUTIONS

GASOLINE ENGINE TOOLS

BL "SAKISUBO" Bit, 3-pc set | S3P



- SAKISUBO bits whose constricted part acts as a cushion, absorbing the shock from power impact tools.
- Optimal for fastening joists, staircase construction, concrete panels, sash attachment and interior fixtures.

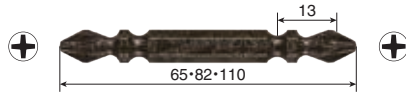

Code No.	Model No.	Contents	Card size (mm)	JAN (4907587)
485371	S3P2065-BL	⌀2× 65 3pcs.	160×43×8	501011
485372	S3P2082-BL	⌀2× 82 3pcs.	160×43×8	501028
485373	S3P2110-BL	⌀2×110 3pcs.	160×43×8	501035

SPQ: 10 sets

BL Rib Bit, 3-pc set | RB3P



- Tip with rib that enhances the strength.
- Optimal for iron and steel work.

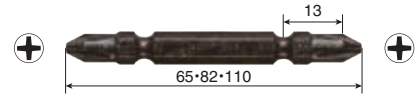

Code No.	Model No.	Contents	Card size (mm)	JAN (4907587)
485374	RB3P2065-BL	⌀2× 65 3pcs.	160×43×8	501042
485375	RB3P2082-BL	⌀2× 82 3pcs.	160×43×8	501059
485376	RB3P2110-BL	⌀2×110 3pcs.	160×43×8	501066

SPQ: 10 sets

BL "SAKISUBO" Bit, 5-pc set | S5P



- Bits in a clip holder with magnetizer.



Code No.	Model No.	Contents	Card size (mm)	JAN (4907587)
485383	S5P2065-BL	⌀2× 65 5pcs.	160×75×23	501134
485384	S5P2082-BL	⌀2× 82 5pcs.	160×75×23	501141
485385	S5P2110-BL	⌀2×110 5pcs.	160×75×23	501158

SPQ: 5 sets

BL Rib Bit, 5-pc set | RB5P



- Bits in a clip holder with magnetizer.



Code No.	Model No.	Contents	Card size (mm)	JAN (4907587)
485386	RB5P2065-BL	⌀2× 65 5pcs.	160×75×23	501165
485387	RB5P2082-BL	⌀2× 82 5pcs.	160×75×23	501172
485388	RB5P2110-BL	⌀2×110 5pcs.	160×75×23	501189

SPQ: 5 sets

BL "SAKISUBO" Torsion Bit, 3-pc set | SST3P



- SAKISUBO shape, in which the constricted part acts as a cushion, absorbing the shock from power impact tools.
- Torsion effect that absorbs the shock generated at the time of seating of the screw.
- Optimal for fastening joists, staircase construction, concrete panels, sash attachment and interior fixtures.

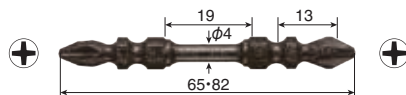

Code No.	Model No.	Contents	Card size (mm)	JAN (4907587)
485377	SST3P2065-BL	⌀2× 65 3pcs.	160×43×8	501073
485378	SST3P2082-BL	⌀2× 82 3pcs.	160×43×8	501080

SPQ: 10 sets

BL Rib Torsion Bit, 3-pc set | RBT3P



- Tip with rib that enhances the strength.
- Torsion effect that absorbs the shock generated at the time of seating of the screw.
- Optimal for iron and steel work.

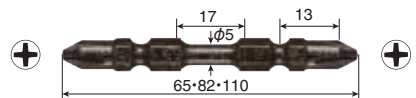

Code No.	Model No.	Contents	Card size (mm)	JAN (4907587)
485380	RBT3P2065-BL	⌀2× 65 3pcs.	160×43×8	501103
485381	RBT3P2082-BL	⌀2× 82 3pcs.	160×43×8	501110
485382	RBT3P2110-BL	⌀2×110 3pcs.	160×43×8	501127

SPQ: 10 sets

BL SAKISUBO Torsion Bit, 5-pc set | SST5P



- Bits in a clip holder with magnetizer.



Code No.	Model No.	Contents	Card size (mm)	JAN (4907587)
485389	SST5P2065-BL	⌀2× 65 5pcs.	160×75×23	501196
485390	SST5P2082-BL	⌀2× 82 5pcs.	160×75×23	501202
485391	SST5P2110-BL	⌀2×110 5pcs.	160×75×23	501219

SPQ: 5 sets

BL Rib Torsion Bit, 5-pc set | RBT5P



- Bits in a clip holder with magnetizer.



Code No.	Model No.	Contents	Card size (mm)	JAN (4907587)
485392	RBT5P2065-BL	⌀2× 65 5pcs.	160×75×23	501226
485393	RBT5P2082-BL	⌀2× 82 5pcs.	160×75×23	501233
485394	RBT5P2110-BL	⌀2×110 5pcs.	160×75×23	501240

SPQ: 5 sets

HAND TOOLS

INDUSTRIAL BITS

CONSTRUCTION BITS

RECIPROCATING SAW BLADES

ELECTRIC TOOLS

AIR TOOLS

AIR NIPPERS

STATIC SOLUTIONS

GASOLINE ENGINE TOOLS

HAND TOOLS

INDUSTRIAL BITS

Double-End Socket | BH-40/41

- 1 socket compatible with multiple drill screws.
- Multi-function socket can also be used as an adapter for bit extension.

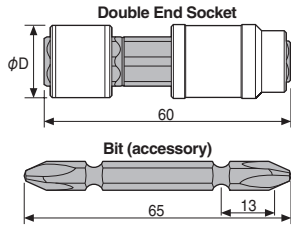

Code No.	Model No.	Socket A/F	φD (mm)	Socket OAL	Bit (Accessory)	Card size (mm)	JAN (4907587)
486761	BH-40	8 9.6	18	60	Φ2×65	160×50	501318
486762	BH-41	8 10	18	60	Φ2×65	160×50	501332

※Metalworking drill: up to dia.6mm
 ※Woodworking drill: up to dia.12mm
 ※Socket bit cannot be linked. SPQ: 5pcs. Outer Ctn.: 50pcs.

"KADOGIWA" Corner Bit for Brace | KDB

- For fastening quake resistant hardware.
- Can be tilted up to 6° at the tip section. Ideal for working at corners.
- For fastening hall-down hardware and brace hardware.



Code No.	Model No.	Contents	Card size (mm)	JAN (4907587)
485421	KDB-SQ3	SQ 3×100 1pc.	160×50×13	347145

SPQ: 10 sets

Replacement Corner Bit | KDB

- Exclusively for the KDB-SQ3.



Code No.	Model No.	Contents	Card size (mm)	JAN (4907587)
485422	KDB-SQ3K	SQ 3× 35 1pc.	135×35×8	347152

SPQ: 10 sets

"BARITORI" Full Tread Deburring Bit | A20ZB

- Burrs of thread studs (made of iron) can be removed by electrical impact tools.
- Optimal for edge surface finish of hanging bolts and anchor bolts.

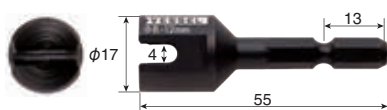

Code No.	Model No.	Applicable	Card size (mm)	JAN (4907587)
485431	A20ZB55	Full Tread (iron)M8, 3/8, M10, M12	160×35×20	347169

SPQ: 5 sets

ONE POINT | BH-40/41

4 usages by 1 socket.

Supports popular sizes for exterior wall work.



Applications: For the construction of exterior walls (siding), roofs, and solar mounts.

ONE POINT



Recessed Plus-Minus Bit

For Phillips/slotted screws that are widely used.
 For tightening terminal screws on distribution board, fitting hardware to hold electric wire, plumbing, and air conditioner installation.



"KADOGIWA" Corner Bit for Brace

The tip section can tilt 6°. Can tighten screws easily in narrow places like corners using impact driver. For fastening hall-down hardware, brace hardware and various seismic hardware.

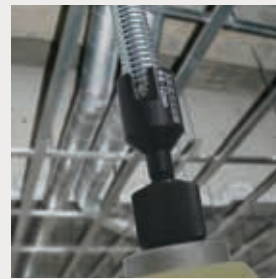

"BARITORI" Full Tread Deburring Bit

Easy to use with impact driver. Excellent durability. Indispensable for work with hanging bolts and installing air conditioning equipment. Ideal for treating edge face of anchor bolt.

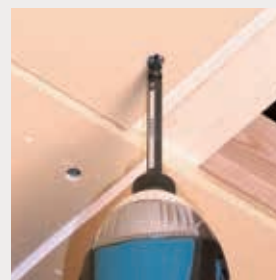

Double End "SAKISUBO" Bit

Improved durability with cushion effect at constricted part. For working with joist, stairs, composite panels, sash frame, interior finishing, etc.

CONSTRUCTION BITS

RECIPROCATING SAW BLADES

ELECTRIC TOOLS

AIR TOOLS

AIR NIPPERS

STATIC SOLUTIONS

GASOLINE ENGINE TOOLS

Double End Combi Bit, 2-pc set | PZ

● PZ2 and PZ3 are combined into one bit.

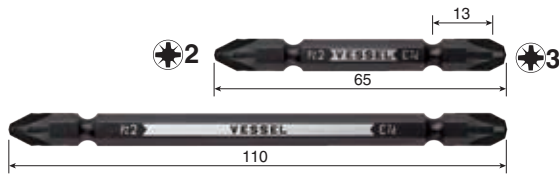

Code No.	Model No.	Contents	Card size (mm)	JAN (4907587)
485401	PZ142365	PZ2/ PZ3× 65 2pcs.	160×35×8	347206
485402	PZ142311	PZ2/ PZ3×110 2pcs.	160×35×8	347084

SPQ: 10 sets

Double End Combi Bit, 2-pc set | PQ

● SQ3 and ⊕2 are combined into one bit.
● ⊕2 has a SAKISUBO shape tip-end, prevents cam-out, and is long life.

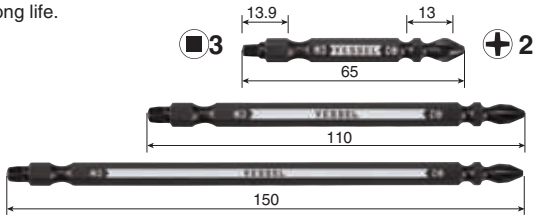

Code No.	Model No.	Contents	Card size (mm)	JAN (4907587)
485406	PQ142365	⊕2 / SQ3× 65 2pcs.	160×35× 8	347091
485407	PQ142311	⊕2 / SQ3×110 2pcs.	160×35× 8	347107
485408	PQ142315S	⊕2 / SQ3×150 1pc.	190×35×17	347190

SPQ: 10 sets

Dedicated Replacement Combi Bit | PD

● Slotted tip used for quick connection terminal such as outlet and frequently-used ⊕2 are combined into one bit.

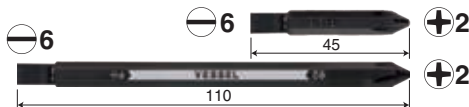

PD142645

PD142611

Code No.	Model No.	Contents	Card size (mm)	JAN (4907587)
485416	PD142645	⊖6 / ⊕2× 45 1pc.	135×35×8	346285
485414	PD142611	⊖6 / ⊕2×110 1pc.	160×35×8	346261

PD142611 applicable models: 220W / 220W-3 / 220W-62 / 220W-123
PD142645 applicable models: 270BW / 270BW-62 / 270BW-123

SPQ: 10 sets

Dedicated Replacement Combi Plus Bit | PD

● Three sizes are combined into one bit.

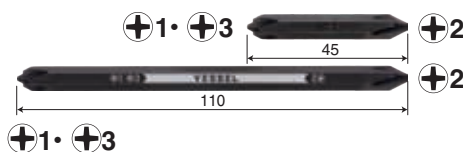

PD1412345

PD1412311

Code No.	Model No.	Contents	Card size (mm)	JAN (4907587)
485415	PD1412345	⊕1 · ⊕3 / ⊕2 × 45 1pc.	135×35×8	346292
485417	PD1412311	⊕1 · ⊕3 / ⊕2 ×110 1pc.	160×35×8	346278

PD1412311 applicable models: 220W / 220W-3 / 220W-62 / 220W-123
PD1412345 applicable models: 270BW / 270BW-62 / 270BW-123

SPQ: 10 sets

Replacement Bit | PD16

● For No.230W Ball-grip (Bit-replaceable Tang-Thru grip)
● Can also be used with electric screwdrivers.



PD162140

PD163140

PD166140

Code No.	Model No.	Contents	Card size (mm)	JAN (4907587)
485418	PD162140	⊕ 2 × 140 1pc.	175×35×8	345400
485419	PD163140	⊕ 3 × 140 1pc.	175×35×8	345417
485420	PD166140	⊖ 6 × 140 1pc.	175×35×8	345424

SPQ: 5 sets

Replacement Bit for the 220USB (Type-A bit) | USB16

● Slim shank type, with tube, not damaging terminal blocks.

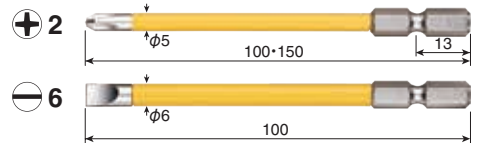

Code No.	Model No.	Contents	Card size (mm)	JAN (4907587)
485801	USB161100	⊕ 1 × φ 4.5 × 100	160×35×8	007704
485802	USB162100	⊕ 2 × φ 5 × 100	160×35×8	007711
485803	USB162150	⊕ 2 × φ 5 × 150	180×35×8	007728
485804	USB163100	⊕ 3 × φ 6 × 100	160×35×8	007735
485805	USB166100	⊖ 6 × φ 6 × 100	160×35×8	007742

SPQ: 10 sets



Cautions

These products are not insulated bits. For safety, cut off electricity before use. Shaft cover is provided to prevent short circuits just in case; do not use if scratched, damaged, deteriorating, etc.

Replacement Bit w/Hex Bolster for the 220USB (Type-A bit) | USB16

● Slim shank type, with tube, not damaging terminal blocks.

● With a hexagon bolster (width across-flats 8mm) to use with a wrench.

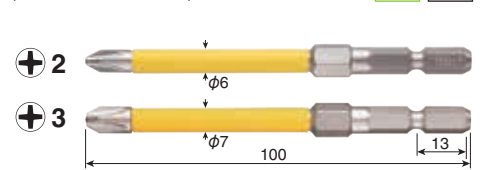

USB162100S8 USB163100S8

Code No.	Model No.	Contents	Card size (mm)	JAN (4907587)
485807	USB162100S8	⊕2×φ6×100	160×35×8	026552
485806	USB163100S8	⊕3×φ7×100	160×35×8	015822

SPQ: 10 sets



Cautions

These products are not insulated bits. For safety, cut off electricity before use. Shaft cover is provided to prevent short circuits just in case; do not use if scratched, damaged, deteriorating, etc.

ONE POINT | PD

Combi PLUS

One bit for 3-size tip-end!
One side is dedicated to frequently-used ⊕2 and another for both ⊕1 and ⊕3.

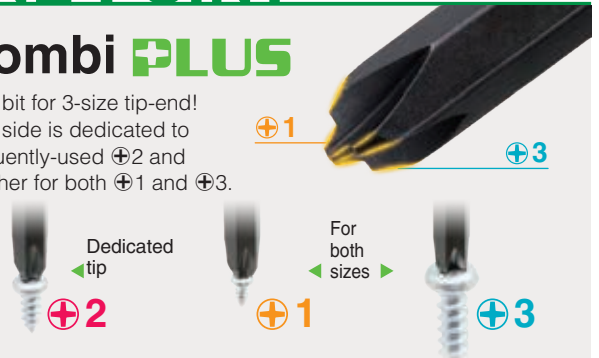

PD1412311 applicable models: 220W / 220W-3 / 220W-62 / 220W-123

PD1412345 applicable models: 270BW / 270BW-62 / 270BW-123

SPQ: 10 sets

HAND TOOLS

INDUSTRIAL BITS

Double End MAGNUM Bit, 2-pc set | MX14

- Long life with ribbed tip and torsion.
- Plastic spring facilitates bit replacement.
- Patented.

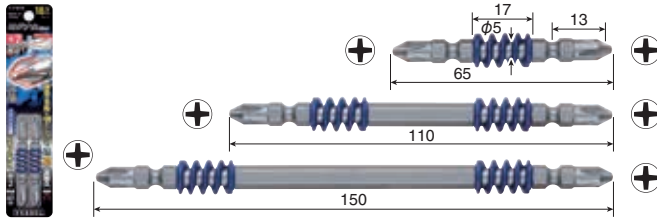

Code No.	Model No.	Contents	Hardness	Card size (mm)	JAN (4907587)
485031	MX142065	⊕2× ϕ 5× 65 2pcs.	H	160×35×8	348210
485033	MX142110	⊕2× ϕ 5×110 2pcs.	H	160×35×8	348234
485034	MX142150	⊕2× ϕ 5×150 2pcs.	H	210×35×8	348241

SPQ: 10 sets

SUPER TORSION Bit, 2-pc set | RT

- Tapered finish enables to see the tip-end.
- Strong tip-end suitable for heavy-duty work, and torsion effect.
- Ultra Hex shank does not damage the chuck.

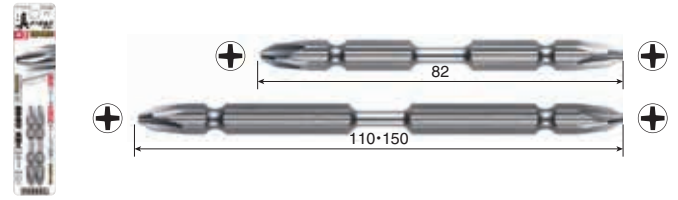

Code No.	Model No.	Contents	Hardness	Card size (mm)	JAN (4907587)
484462	RT142082	⊕2× ϕ 3.7× 82 2pcs.	X	160×35×8	348159
484463	RT142110	⊕2× ϕ 3.7×110 2pcs.	X	160×35×8	348166
484464	RT142150	⊕2× ϕ 3.7×150 2pcs.	X	210×35×8	348173

SPQ: 10 sets

CONSTRUCTION BITS

Double End MAGNUM Bit, 5-pc set | MX5P

- Patented.



MX5P2065 MX5P2110

Code No.	Model No.	Contents	Hardness	Card size (mm)	JAN (4907587)
485051	MX5P2065	⊕2× ϕ 5× 65 5pcs.	H	160×70×8	348296
485052	MX5P2110	⊕2× ϕ 5×110 5pcs.	H	160×70×8	348302

SPQ: 10 sets

SUPER TORSION Bit, 5-pc set | RT5P



RT5P2065 RT5P2082

Code No.	Model No.	Contents	Hardness	Card size (mm)	JAN (4907587)
484471	RT5P2065	⊕2× ϕ 3.7× 65 5pcs.	X	160×70×8	348180
484472	RT5P2082	⊕2× ϕ 3.7× 82 5pcs.	X	160×70×8	348197

SPQ: 10 sets

RECIPROCATING SAW BLADES

ELECTRIC TOOLS

Recessed MAGNUM Bit, 2-pc set | MX16

- Long life with ribbed tip and torsion.
- Plastic spring facilitates bit replacement.
- Patented.

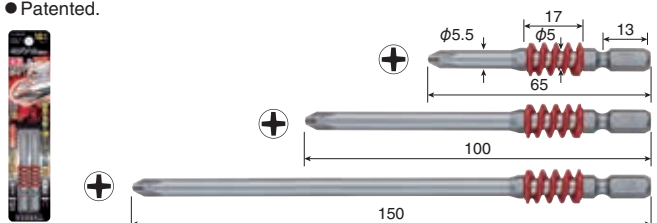

Code No.	Model No.	Contents	Hardness	Card size (mm)	JAN (4907587)
485035	MX162065	⊕2× ϕ 5× 65 2pcs.	H	160×35×8	348258
485037	MX162100	⊕2× ϕ 5×100 2pcs.	H	160×35×8	348272
485038	MX162150	⊕2× ϕ 5×150 2pcs.	H	210×35×8	348289

SPQ: 10 sets

SUPER TORSION Bit, 10-pc set | RT10P



RT10P2065F RT10P2082F RT10P2110F

Code No.	Model No.	Contents	Hardness	Package size (mm)	JAN (4907587)
413441	RT10P2065F	⊕2× ϕ 3.7× 65 10pcs.	X	143×87×7	320469
413442	RT10P2082F	⊕2× ϕ 3.7× 82 10pcs.	X	143×87×7	320476
413443	RT10P2110F	⊕2× ϕ 3.7×110 10pcs.	X	162×87×7	320483

SPQ: 10 sets

AIR TOOLS

AIR NIPPERS

STATIC SOLUTIONS

Recessed MAGNUM Bit, 5-pc set | MX5P

- Patented.



MX5P2065D MX5P2100D

Code No.	Model No.	Contents	Hardness	Card size (mm)	JAN (4907587)
485053	MX5P2065D	⊕2× ϕ 5× 65 5pcs.	H	160×70×8	348319
485054	MX5P2100D	⊕2× ϕ 5×100 5pcs.	H	160×70×8	348326

SPQ: 10 sets

ONE POINT

Ribs protect the tip-end! Resistant to twisting!

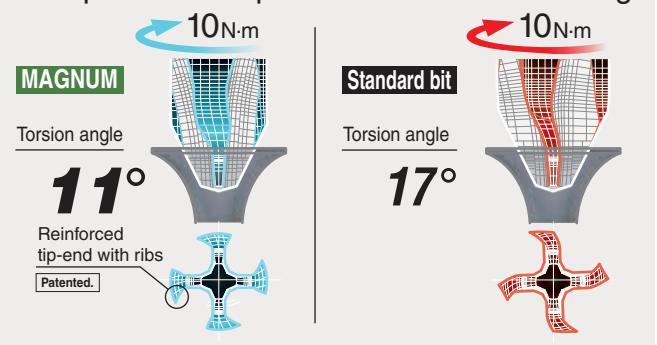

Slender Bit, 2-pc set | AS

- Tapered tip-end suitable for slim screws.
- For soft joints using wood screws, plastic tapping screws, etc.

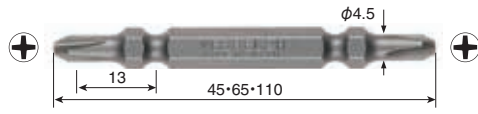

Code No.	Model No.	Contents	Hardness	Card size (mm)	JAN (4907587)
486187	AS141065	⊕1× 65 2pcs.	H	160×35×8	354303
486186	AS142045	⊕2× 45 2pcs.	H	160×35×8	354297
486184	AS142065	⊕2× 65 2pcs.	H	160×35×8	353900
486185	AS142110	⊕2×110 2pcs.	H	160×35×8	353917

SPQ: 10 sets

Slender Bit, 5-pc set | BW



BW-180 BW-181



Code No.	Model No.	Contents	Hardness	Card size (mm)	JAN (4907587)
486650	BW-180	⊕2× 65 5pcs.	H	140×70×23	353924
486651	BW-181	⊕2×110 5pcs.	H	140×70×23	353931

Comes with one bit holder SPQ: 10 sets

SLENDER Bit, 5-pc set | AS5P



AS5P1065F AS5P2065F

AS5P2110F



Code No.	Model No.	Contents	Hardness	Package size (mm)	JAN (4907587)
485441	AS5P1065F	⊕1× 65 5pcs.	H	135×50×7	349644
485442	AS5P2065F	⊕2× 65 5pcs.	H	135×50×7	349651
485443	AS5P2110F	⊕2×110 5pcs.	H	160×50×7	349668

SPQ: 10 sets

Slender Bit, 20-pc set | AS20P



AS20P2110F



Code No.	Model No.	Contents	Hardness	Package size (mm)	JAN (4907587)
484482	AS20P2110F	⊕2×110 20pcs.	H	162×87×14	320520

SPQ: 5 sets

Cushion Bit, 2-pc set | AC

- Cushion ring reduces the run-out of the bit.
- Ultra Hex shank does not damage the chuck.

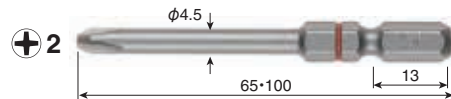
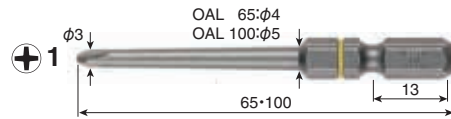
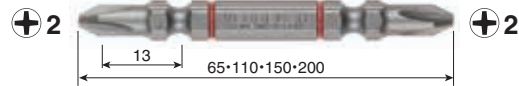
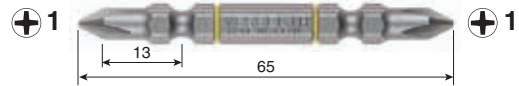

Code No.	Model No.	Contents	Hardness	Card size (mm)	JAN (4907587)
484376	AC141065	⊕1× 65 2pcs.	H	160×35×8	357519
484378	AC142065	⊕2× 65 2pcs.	H	160×35×8	357526
484379	AC142110	⊕2×110 2pcs.	H	160×35×8	357533
484380	AC142150	⊕2×150 2pcs.	H	210×35×8	357540
484381	AC142200	⊕2×200 2pcs.	H	260×35×8	357557
484386	AC161065	⊕1×φ4 × 65 2pcs.	H	160×35×8	357564
484387	AC161100	⊕1×φ5 ×100 2pcs.	H	160×35×8	357571
484388	AC162065	⊕2×φ4.5× 65 2pcs.	H	160×35×8	357588
484389	AC162100	⊕2×φ4.5×100 2pcs.	H	160×35×8	357595

*The colors in the table indicate the ring color.

SPQ: 10 sets

ONE POINT

Bit Selection

- Different tip-end for various application.

STANDARD AX

Good for most screws in the market with different depths of screw head hole.



SLENDER AS

Tapered tip allows for easy view of small screw head, so that the bit tip fits a screw head hole quickly.



GIZA AZ

Jagged tip prevents cam-out, a typical problem to cross recessed screws.



JAWS FIT JA

Sharp protrusion at the slot of the tip fits screw head hole firmly, preventing cam-out.



HAND TOOLS

INDUSTRIAL BITS

CONSTRUCTION BITS

RECIPROCATING SAW BLADES

ELECTRIC TOOLS

AIR TOOLS

AIR NIPPERS

STATIC SOLUTIONS

GASOLINE ENGINE TOOLS

Extra Hard Bit, 2-pc set

AX

- Highest hardness 62HRC bit, suitable for stainless steel screws and plaster board screws.

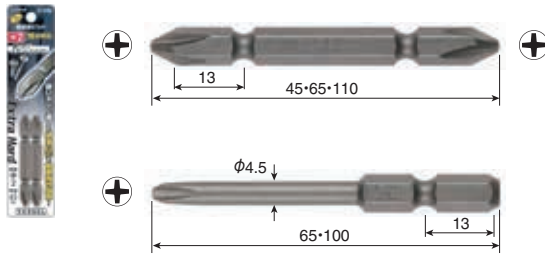

Code No.	Model No.	Contents	Hardness	Card size (mm)	JAN (4907587)
486192	AX142045	⊕2× 45 2pcs.	X	160×35×8	354808
486193	AX142065	⊕2× 65 2pcs.	X	160×35×8	354815
486194	AX142110	⊕2×110 2pcs.	X	160×35×8	354822
486195	AX162065	⊕2×φ4.5× 65 2pcs.	X	160×35×8	354839
486196	AX162100	⊕2×φ4.5×100 2pcs.	X	160×35×8	354846

SPQ: 10 sets

Extra Hard Bit, 5-pc set

BW



BW-36 BW-37 BW-39

Code No.	Model No.	Contents	Hardness	Card size (mm)	JAN (4907587)
486596	BW-36	⊕2× 65 5pcs.	X	140×70×23	356581
486597	BW-37	⊕2×110 5pcs.	X	140×70×23	356598
486599	BW-39	⊕2×φ4.5×100 5pcs.	X	140×70×23	356611

Comes with one bit holder. SPQ: 10 sets

GIZA Bit, 2-pc set

AZ

- Jagged tip-end prevents cam-out.
- Suitable for screw tightening even in the poorly scaffolded area or in an unstable place.

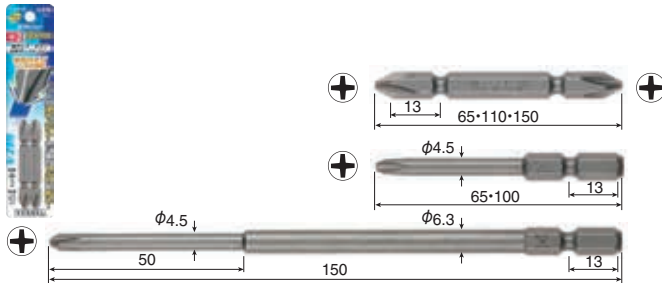

Code No.	Model No.	Contents	Hardness	Card size (mm)	JAN (4907587)
486177	AZ142065	⊕2× 65 2pcs.	H	160×35×8	353122
486178	AZ142110	⊕2×110 2pcs.	H	160×35×8	353139
486179	AZ142150	⊕2×150 2pcs.	H	210×35×8	353146
486181	AZ162065	⊕2×φ4.5× 65 2pcs.	H	160×35×8	353160
486182	AZ162100	⊕2×φ4.5×100 2pcs.	H	160×35×8	353177
486183	AZ162150	⊕2×φ4.5×φ6.3×150 2pcs.	H	210×35×8	353184

SPQ: 10 sets

JAWS Bit, 2-pc set

JA

- JAWS FIT tip fits screw head recess.
- Reliable work possible as this tip prevents screws from falling over.
- Patented.

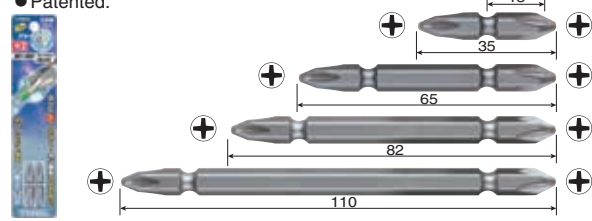

Code No.	Model No.	Contents	Hardness	Card size (mm)	JAN (4907587)
484450	JA142035	⊕2× 35 2pcs.	H	160×35×8	357380
484451	JA142065	⊕2× 65 2pcs.	H	160×35×8	357397
484452	JA142082	⊕2× 82 2pcs.	H	160×35×8	357403
484453	JA142110	⊕2×110 2pcs.	H	160×35×8	357410

SPQ: 10 sets

JAWS Bit, 5-pc set

JA5P

- Patented.



JA5P2065 JA5P2082 JA5P2110

Code No.	Model No.	Contents	Hardness	Card size (mm)	JAN (4907587)
484456	JA5P2065	⊕2× 65 5pcs.	H	160×70×8	357458
484457	JA5P2082	⊕2× 82 5pcs.	H	160×70×8	357465
484458	JA5P2110	⊕2×110 5pcs.	H	160×70×8	357472

SPQ: 10 sets

Tapping Bit, 2-pc set

A14H

- For heavy-duty work, with cross blades whose thickness is increased.
- Suitable for screws for sash frames with a thread size of about 4mm.

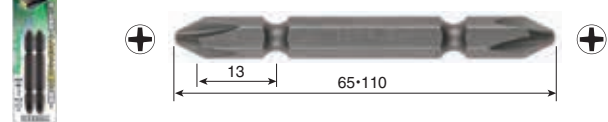

Code No.	Model No.	Contents	Hardness	Card size (mm)	JAN (4907587)
486190	A14H2065	⊕2× 65 2pcs.	H	160×35×8	354310
486191	A14H2110	⊕2×110 2pcs.	H	160×35×8	354327

Inner Ctn.: 10 sets

Square Double End Bit, 2-pc set

A14SQ

- Bit for square screws mostly used for sash frames and quake resistant hardware.

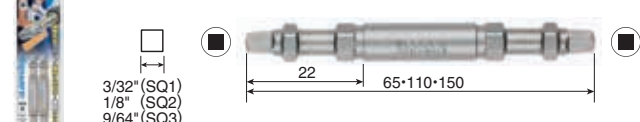

Code No.	Model No.	Contents	Hardness	Card size (mm)	JAN (4907587)
486219	A14SQ1065	SQ 1× 65 2pcs.	H	160×35×8	355508
486208	A14SQ2065	SQ 2× 65 2pcs.	H	160×35×8	355379
486210	A14SQ2110	SQ 2×110 2pcs.	H	160×35×8	355393
486220	A14SQ2150	SQ 2×150 2pcs.	H	210×35×8	355515
486209	A14SQ3065	SQ 3× 65 2pcs.	H	160×35×8	355386
486211	A14SQ3110	SQ 3×110 2pcs.	H	160×35×8	355409
486221	A14SQ3150	SQ 3×150 2pcs.	H	210×35×8	355522

SPQ: 10 sets

Square Double End Bit, 2-pc set | A14RSQ



- For square screws popular for sash frames and quake resistant hardware.
- The ring keeps the bit from getting stuck in the chuck.

RoHS

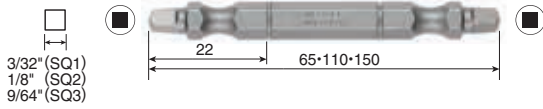

Code No.	Model No.	Contents	Hardness	Card size (mm)	JAN (4907587)
486222	A14RSQ1065	SQ 1× 65 2pcs.	H	160×35×8	355584
486224	A14RSQ2110	SQ 2×110 2pcs.	H	160×35×8	355607
486225	A14RSQ2150	SQ 2×150 2pcs.	H	210×35×8	355614
486227	A14RSQ3110	SQ 3×110 2pcs.	H	160×35×8	355638

SPQ: 10 sets

Square Double End Bit, 5-pc set | BW



BW-401 BW-403 BW-407

RoHS

Code No.	Model No.	Contents	Hardness	Card size (mm)	JAN (4907587)
486850	BW-401	SQ 2× 65 5pcs.	H	140×70×23	355652
486852	BW-403	SQ 2×110 5pcs.	H	140×70×23	355676
486856	BW-407	SQ 2× 65 1pc.	H	140×70×23	355713
		SQ 3× 65 2pcs.	H		
		SQ 2×110 1pc.	H		
		SQ 3×110 1pc.	H		

Comes with one bit holder. Outer ctn.: 10 sets

Square Bit, 2-pc set | M16SQ



- For square screws popular for sash frames and quake resistant hardware.

RoHS

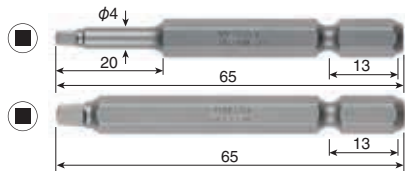

Code No.	Model No.	Contents	Card size (mm)	JAN (4907587)
486155	M16SQ1065	SQ 1× 65 2pcs.	160×35×8	355348
486156	M16SQ2065	SQ 2× 65 2pcs.	160×35×8	355355

SPQ: 10 sets

Hex Bit | SM16H



- For hexagon socket head bolts or set screws commonly used for machines and facilities, cars and motorcycles.

RoHS



Code No.	Model No.	Contents	Card size (mm)	JAN (4907587)
486671	SM16H020	H 2 × 65 1pc.	135×35×8	356352
486672	SM16H025	H 2.5× 65 1pc.	135×35×8	356369
486673	SM16H030	H 3 × 65 1pc.	135×35×8	356376
486674	SM16H040	H 4 × 65 1pc.	135×35×8	356383
486675	SM16H050	H 5 × 65 1pc.	135×35×8	356390
486676	SM16H060	H 6 × 65 1pc.	135×35×8	356406
486677	SM16H080	H 8 × 65 1pc.	135×35×8	358479

SPQ: 10 sets

HEX Bit, 5-pc set | BW



RoHS



Code No.	Model No.	Contents	Card size (mm)	JAN (4907587)
486591	BW-31	H2.5, 3, 4, 5, 6×65 1pc. each	140×70×23	356574

Comes with one bit holder. Outer ctn.: 10 sets

TORX® Bit (Tamper-Proof) | SMVT



- For TORX® screws used in the automobile industry.
- With a round hole for tamper-proof.

RoHS



Code No.	Model No.	Contents	Card size (mm)	JAN (4907587)
486681	SMVT08H	T 8H× 65 1pc.	135×35×8	356413
486682	SMVT10H	T 10H× 65 1pc.	135×35×8	356420
486683	SMVT15H	T 15H× 65 1pc.	135×35×8	356437
486684	SMVT20H	T 20H× 65 1pc.	135×35×8	356444
486685	SMVT25H	T 25H× 65 1pc.	135×35×8	356451
486686	SMVT27H	T 27H× 65 1pc.	135×35×8	356468
486687	SMVT30H	T 30H× 65 1pc.	135×35×8	356475
486688	SMVT40H	T 40H× 65 1pc.	135×35×8	356482

TORX® is a registered trademark of Acument Intellectual Properties, LLC (USA). VESSEL is an official licensee of Acument Intellectual Properties, LLC. SPQ: 10 sets

Ball Point Bit | SM16BP



- For bolts with holes or set screws commonly used for machines and facilities, cars and motorcycles.

RoHS



Code No.	Model No.	Contents	Card size (mm)	JAN (4907587)
486696	SM16BP40	H 4 × 82 1pc.	160×35×8	358806
486698	SM16BP60	H 6 × 82 1pc.	160×35×8	358820

SPQ: 10 sets

HAND TOOLS

INDUSTRIAL BITS

CONSTRUCTION BITS

RECIPROCATING SAW BLADES

ELECTRIC TOOLS

AIR TOOLS

AIR NIPPERS

STATIC SOLUTIONS

GASOLINE ENGINE TOOLS

HAND TOOLS

Ball Quick Catcher

QB-22 NEW

- Lightweight design using reinforced plastic.
- Cushion grip for a soft hand touch.
- Anodized finish resistant to discoloration.
- Can be used as a screwdriver.
(Use for screws M4 or smaller.)



QB-22R QB-22Y QB-22G QB-22V QB-22K



INDUSTRIAL BITS

Quick Catcher

QB-10

- Bit can be replaced with just one hand.
- Smooth surface finish and pull-up type sleeve prevent tools from dropping.
- Strong ball chuck enables to mount a tool up to 500g.
- Flat ring with large diameter is easy to attach to a karabiner, etc.



QB-10R QB-10B QB-10Y QB-10K

→See P127 One point

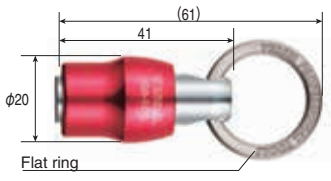

CONSTRUCTION BITS

Code No.	Model No.	Contents	Card size (mm)	JAN (4907587)
486931	QB-22R	Ball Quick Catcher (Red) 1pc.	120×50×26	027573
486932	QB-22Y	Ball Quick Catcher (Yellow) 1pc.	120×50×26	027580
486933	QB-22G	Ball Quick Catcher (Green) 1pc.	120×50×26	027597
486934	QB-22V	Ball Quick Catcher (Violet) 1pc.	120×50×26	027603
486920	QB-22K	Ball Quick Catcher (Black) 1pc.	120×50×26	030276

SPQ: 10 sets

Code No.	Model No.	Contents	Card size (mm)	JAN (4907587)
486921	QB-10R	Quick Catcher (Red) 1pc.	135×50×22	359544
486922	QB-10B	Quick Catcher (Blue) 1pc.	135×50×22	359551
486923	QB-10Y	Quick Catcher (Yellow) 1pc.	135×50×22	359568
486919	QB-10K	Quick Catcher (Black) 1pc.	135×50×22	030269

SPQ: 10 sets Outer Ctn.: 100 sets

RECIPROCATING SAW BLADES

Ball Quick Catcher 2-pc set QB-22K2 NEW

- 2pcs set of Ball Quick Catcher. Comes with a karabiner.
- Lightweight design using reinforced plastic.
- Cushion grip for a soft hand touch.
- Can be used as a screwdriver.



QB-22K2RY QB-22K2GV

Code No.	Model No.	Set Contents	Card size (mm)	JAN (4907587)
486935	QB-22K2RY	Ball Quick Catcher (red-yellow), Karabiner (Black) 1pc. each	157×56×26	027610
486936	QB-22K2GV	Ball Quick Catcher (green-violet), Karabiner (Black) 1pc. each	157×56×26	027627

SPQ: 10 sets

Quick Catcher 3-pc set

QB-K3C

- Bit can be replaced with just one hand.
- Smooth surface finish and pull-up type sleeve prevent tools from dropping.
- Strong ball chuck enables to mount a tool up to 500g.
- Comes with a karabiner to hang onto your belt, etc.



→See P127 One point

Code No.	Model No.	Contents	Card size (mm)	JAN (4907587)
486924	QB-K3C	Quick catcher (Red-Blue-Yellow), Karabiner (Black) 1pc. each	135×50×45	359681

SPQ: 10 sets Outer Ctn.: 100 sets

AIR TOOLS

AIR NIPPERS

ONE POINT QB-22

- Auto-lock by simply inserting.**
- Can tighten screws with a bit mounted.**
(Use with M4 or smaller screws.)
- One-push removal with one hand.**

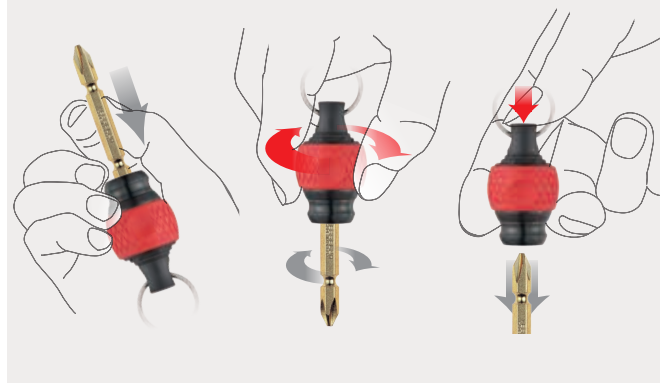

STATIC SOLUTIONS

GASOLINE ENGINE TOOLS

Quick Catcher w/Key Adapter QB-KBAD NEW

- Bit can be replaced with just one hand.
- Smooth surface finish and pull-up type sleeve prevent tools from dropping.
- With a key adapter of a flat blade for prizing, which can also be used to open paint can lids.
- Comes with a karabiner to hang onto your belt, etc.



→See P127 One point

Code No.	Model No.	Contents	Card size (mm)	JAN (4907587)
486925	QB-KBAD	Quick catcher(BK), Key adapter, Karabiner(BK) 1pc. Each	135×50×31	359698

SPQ: 10 sets Outer Ctn.: 100 sets

Key Adapter

| QB-AD

- Key adapter for Quick Catcher QB series.
- A flat blade for prizing, which can also be used to open paint can lids.
- Large-diameter ring for easy attachment to a karabiner, etc.

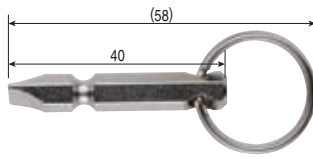

Code No.	Model No.	Contents	Card size (mm)	JAN (4907587)
486926	QB-AD	Key adapter 1pc.	135×50×9	359704

SPQ: 10 sets Outer Ctn.: 100 sets

ONE POINT

| QB

Insert and remove with one hand.

Pick up the sleeve and pull it out.

Auto-lock by inserting.



Bit Belt Holder

| BB

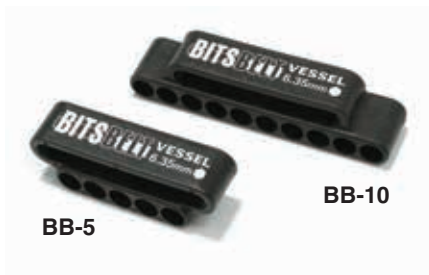

Code No.	Model No.	Contents	Package size (mm)	JAN (4907587)
486579	BB-5	Bit Belt Holder for 5pcs.	158×78×28	358684
486580	BB-10	Bit Belt Holder for 10pcs.	118×98×38	358691

SPQ: 10 sets Outer Ctn.: 100 sets

Bit Holder

| BH-05 NEW

- Can carry 5 pieces of bit.
- 4-color variations. Choose your favorite color according to the bit and the application.
- W/hanging hole for attachment to a karabiner.



BH-05R BH-05N BH-05D BH-05K



Code No.	Model No.	Content	Card size (mm)	JAN (4907587)
482444	BH-05R	Bit holder for 5pcs (Red)×1	140×35×16	31921
482445	BH-05N	Bit holder for 5pcs (Navy)×1	140×35×16	31938
482446	BH-05D	Bit holder for 5pcs (OD)×1	140×35×16	31945
482447	BH-05K	Bit holder for 5pcs (Black)×1	140×35×16	31952

SPQ: 10 pcs. Outer Ctn.: 100 pcs.

HAND TOOLS

INDUSTRIAL BITS

CONSTRUCTION BITS

RECIPROCATING SAW BLADES

ELECTRIC TOOLS

AIR TOOLS

AIR NIPPERS

STATIC SOLUTIONS

GASOLINE ENGINE TOOLS

MTA
Super Hard Forged
Mirror Socket

Shock absorption
material prevents
shank
breakage!



Super hard forged (=“GO-TAN”) mirror sockets feature a polished “mirror finish”. The step-free, streamlined design fits securely in the hand. Lightweight and compact. The deep hole type is especially suitable for tightening nuts, and is also ideal for roof work.



MTA20
Super Hard Forged Mirror Socket

Most versatile semi-long size. Shock absorption material & torsion prevent breakage. Hexagonal surface contact supports even nuts that have been just rounded. Streamlined design fits comfortably in the palm of the hand. Anti-resistant mirror finish. 10 sizes.

Patented
Hexagonal surface contact

Surface contact without damaging the corner of the bolt or nut.

Patented
Press-fit shaft for improved durability

Torsion effect on the shaft part reduces shaft breakage.

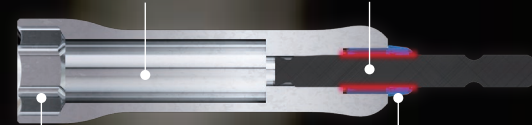

Deep hole type

Suitable for roofs and solar panels because the bolt clearance is long.

Shock absorbing material

Reduces stress concentration on the shaft during impact.



"GO-TAN" (Hard Forged) Semi-long Socket | SL

- The most versatile medium length socket.
- Streamlined mirror finish (chrome plating) and excellent rust-proof socket.
- Surface contact type hexagonal socket.
- Patented.

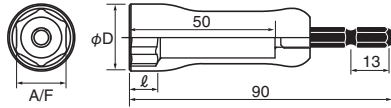

Code No.	Model No.	A/F	φD	ℓ	Overall Length (mm)	Package size (mm)	JAN (4907587)
486741	SL200790	7	11	6.5	90	143×35	359612
486731	SL200890	8	14	6.5	90	143×35	359445
486742	SL200990	9	15	6.5	90	143×35	359629
486732	SL201090	10	16	6.5	90	143×35	359452
486743	SL201190	11	17	7	90	143×35	359636
486733	SL201290	12	18	7.5	90	143×35	359469
486734	SL201390	13	19	8	90	143×35	359476
486735	SL201490	14	20	8	90	143×35	359483
486744	SL201590	15	21	8	90	143×35	359643
486736	SL201790	17	23	9	90	143×35	359490
486737	SL201990	19	25	10	90	143×35	359506
486738	SL202190	21	28	11	90	143×35	359513
486739	SL202290	22	29	12	90	143×35	359520
486740	SL202490	24	32	13	90	143×35	359537

*The colors of the A/F column in the table indicate the seal colors.

SPQ: 5 pcs. Outer Ctn.: 100 pcs.

"GO-TAN" (Hard Forged) Mirror Socket | TA

- With a shank press-fit into the socket with resin, reducing the concentration of stress on the shank part when impact is applied.
- Streamlined mirror finish (chrome plating) and excellent rust-proof socket.
- Surface contact type hexagonal socket.
- Patented.

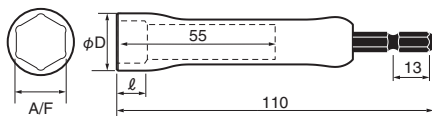

Code No.	Model No.	A/F	φD	ℓ	Overall Length (mm)	Package size (mm)	JAN (4907587)
485012	TA201211	12	18	7.5	110	165×35	358370
485021	TA202111	21	28	11	110	165×35	358424
485022	TA202211	22	29	13	110	165×35	358431
485024	TA202411	24	32	13	110	165×35	358448

*The colors of the A/F column in the table indicate the seal colors.

SPQ: 5 pcs. Outer Ctn.: 100 pcs.

Super Hard Forged Mirror Socket | MTA

- 5 times more durable! The shaft is integrally molded with resin and press-fitted to reduce the stress concentration on the shaft during impact. (A/F8 and A/F10 are 2.5 times more durable.)
- Color-coded by size, easy to find.
- Streamlined design that fits comfortably in the palms of your hands.
- Mirror finish provides excellent rust resistance.
- Surface contact type hexagonal socket.
- Patented.

RoHS

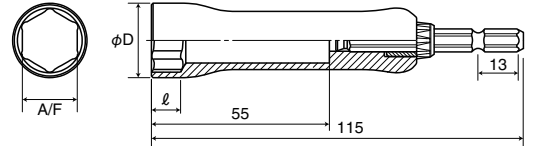

← See P128

Code No.	Model No.	A/F	φD	ℓ	Overall Length (mm)	Package size (mm)	JAN (4907587)
485061	MTA200811	8	14	6.5	115	170×35	026699
485062	MTA201011	10	16	6.5	115	170×35	026705
485063	MTA201211	12	18	7.5	115	170×35	026712
485064	MTA201311	13	19	8	115	170×35	026729
485065	MTA201411	14	20	8	115	170×35	026736
485066	MTA201711	17	23	9	115	170×35	026743
485067	MTA201911	19	25	10	115	170×35	026750
485068	MTA202111	21	28	11	115	170×35	026767
485069	MTA202211	22	29	13	115	170×35	026774
485070	MTA202411	24	32	13	115	170×35	026781

*The colors of the A/F column in the table indicate the color of the seal and damper.

SPQ: 5 pcs. Outer Ctn.: 100 pcs.

"GO-TAN" (Hard Forged) Tilt Short Socket | WSA

- Pull the hex shank to tilt and push it to fix.
- Ideal for work at the corner and in cramped spaces.
- The 15-degree tilting design is excellent for torque transmission. The socket doesn't rattle or damage nuts.

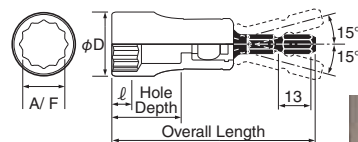
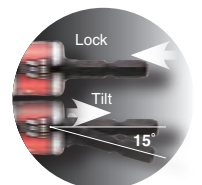

Code No.	Model No.	A/F	φD	ℓ	Hole Depth	Overall Length (mm)	Package size (mm)	JAN (4907587)
486751	WSA2008	8	13	6.5	25	75	130×35	359810
486752	WSA2010	10	16	6.5	25	75	130×35	359827
486753	WSA2012	12	18	7.5	25	75	130×35	359834
486754	WSA2013	13	19	8	25	75	130×35	359841
486755	WSA2014	14	20	8	25	75	130×35	359858
486756	WSA2017	17	23	9	25	75	130×35	359865
486757	WSA2019	19	25	10	25	75	130×35	359872
486758	WSA2021	21	28	11	30	80	140×35	359889
486759	WSA2024	24	32	13	35	85	145×35	359896

*The colors of the A/F column in the table indicate the seal colors.

SPQ: 5 pcs. Outer Ctn.: 100 pcs.

HAND TOOLS

INDUSTRIAL BITS

CONSTRUCTION BITS

RECIPROCATING SAW BLADES

ELECTRIC TOOLS

AIR TOOLS

AIR NIPPERS

STATIC SOLUTIONS

GASOLINE ENGINE TOOLS

"GO-TAN" Tilt Short Sockets, 9-pc set | WSA209PS

- Pull the hex shank to tilt and push it to fix.
- Ideal for work at the corner and in cramped spaces.
- The 15-degree tilting design is excellent for torque transmission. The socket doesn't rattle or damage nuts.



Code No.	Model No.	Set Contents	Case size (mm)	JAN (4907587)
486760	WSA209PS	"GO-TAN" (Hard Forged) Tilt Short Socket 1pc. each A/F8, 10, 12, 13, 14, 17, 19, 21, 24	227×105×38	359902

"GO-TAN" Semi-long Socket, 9-pc set | SL209PS

- Most versatile semi-long size.
- Streamlined design fits comfortably in the palm of the hand and has excellent anti-rust properties with a mirror finish (chrome plating).
- Surface contact type hexagonal sockets.



Code No.	Model No.	Set Contents	Case size (mm)	JAN (4907587)
486745	SL209PS	"GO-TAN" (Hard Forged) Semi-long Socket 1pc. each A/F8, 10, 12, 13, 14, 17, 19, 21, 24	227×105×38	357991

Tilt Socket | WA

- Can be used normally as a deep hole type socket. At the corner, can be used as a tilt socket.
- Surface contact dodecagonal socket for easy fitting to bolts and nuts for improved workability.
- Patented.

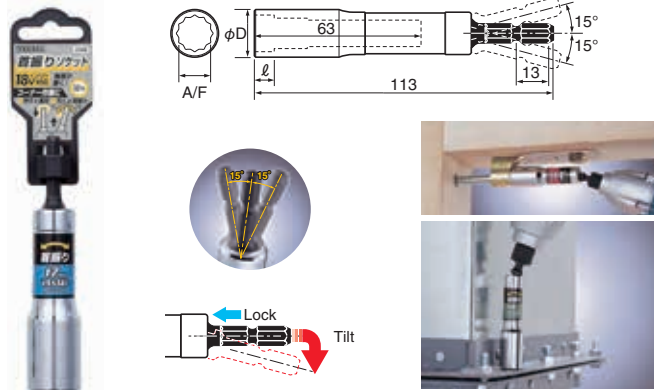

Code No.	Model No.	A/F	φD	ℓ	Overall Length (mm)	Package size (mm)	JAN (4907587)
486361	WA201011	10	16	6.5	113	165×35	356017
486362	WA201211	12	18	7.5	113	165×35	355843
486363	WA201311	13	19	8	113	165×35	355850
486364	WA201411	14	20	8	113	165×35	355867
486365	WA201711	17	23	9	113	165×35	355874
486366	WA201911	19	25	10	113	165×35	355881
486367	WA202111	21	28	11	113	165×35	355898
486368	WA202211	22	29	13	113	165×35	357663
486369	WA202411	24	32	13	113	165×35	357670

※The colors of the A/F column in the table indicate the seal colors. SPQ: 5 pcs. Outer Ctn.: 100 pcs.

Deep Hole Socket | LA

- Deep hole type, suitable for work with nuts.
- Surface contact dodecagonal socket for easy fitting to bolts and nuts for improved workability.

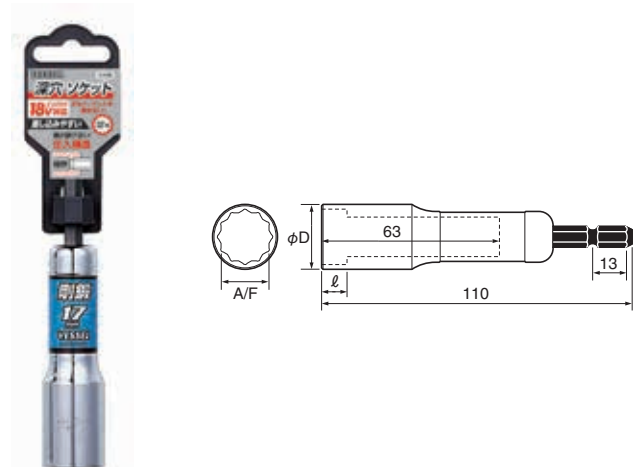

Code No.	Model No.	A/F	φD	ℓ	Overall Length (mm)	Package size (mm)	JAN (4907587)
486140	LA200811	8	14	6.5	110	165×35	345684
486141	LA201011	10	16	6.5	110	165×35	345691
486142	LA201211	12	18	7.5	110	165×35	345707
486143	LA201311	13	19	8	110	165×35	345714
486144	LA201411	14	20	8	110	165×35	345721
486145	LA201711	17	23	9	110	165×35	345738
486146	LA201911	19	25	10	110	165×35	345745
486147	LA202111	21	28	11	110	165×35	345752
486148	LA202211	22	29	13	110	165×35	357687
486149	LA202411	24	32	13	110	165×35	345769

※The colors of the A/F column in the table indicate the seal colors. SPQ (Inner Ct.): 5 pcs. Outer Ctn.: 100 pcs. (LA202411 is supplied only by inner ctn.)

Strut Channel Socket | KAR20

- Very thin hexagonal socket, preventing its head from being obstructed by the strut channel frame.
- Special hexagonal shape in consideration of less damage on each edge of the nut.
- Deep hole in the box assuring to tighten long head screws, too.

RoHS

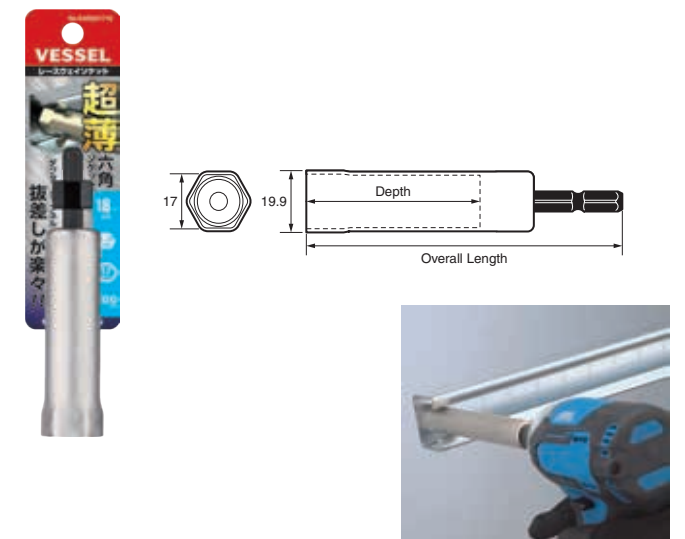

Code No.	Model No.	A/F	Outer width	Depth	Overall Length (mm)	Package size (mm)	JAN (4907587)
484424	KAR201710	17	19.9	55	100	155×35×21	357489
484425	KAR201715	17	19.9	105	150	205×35×21	357496
484426	KAR201730	17	19.9	255	300	355×35×21	015839

SPQ: 5 pcs.

"KUROTAN" Socket

HA

- All blackening finish that professionals prefer.
- Improved durability because of the structure that disperses impact.
- Surface contact type hexagonal socket.
- Patented.

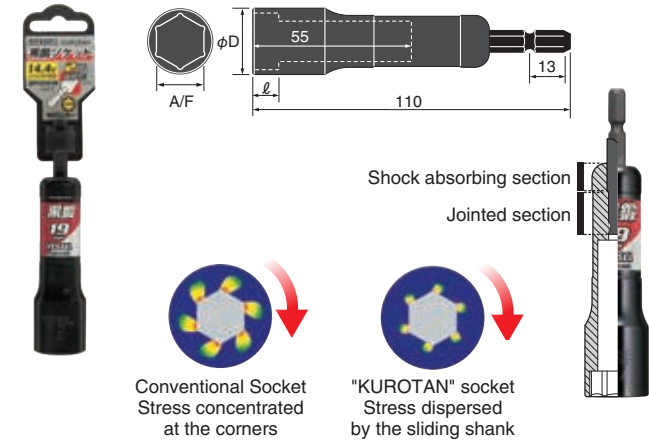

Code No.	Model No.	A/F	φD	ℓ	Overall Length (mm)	Package size (mm)	JAN (4907587)
486117	HA201911	19	25	10	110	160×35	357731
486118	HA202111	21	28	11	110	160×35	357748

※The colors of the A/F column in the table indicate the seal colors. SPQ: 5 pcs. Outer Ctn.: 100 pcs.

Scaffold Worker Socket

LAS

- Socket dedicated to scaffolding work, supporting clamps.
- Surface contact dodecagonal socket for easy fitting to bolts and nuts for improved workability.

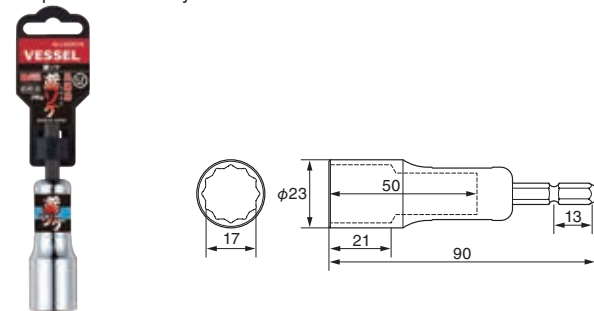

Code No.	Model No.	A/F	Outer Dia.	ℓ	Overall Length (mm)	Package size (mm)	JAN (4907587)
486150	LAS20179	17	23	21	90	146×35	345998

※The colors of the A/F column in the table indicate the seal colors. SPQ: 5 pcs. Outer Ctn.: 100 pcs.

Scaffold Worker Socket <JAWS LOCK> | MLS NEW

- Uniquely designed hexagonal "JAWS LOCK".
- The wide contact surface securely catches even rounded bolts.
- When loosening, the jaggings bite down firmly on the bolt.
- Torsion effect and shock absorption material prevent shaft breakage. 5 times more durable than conventional models.
- Patented.

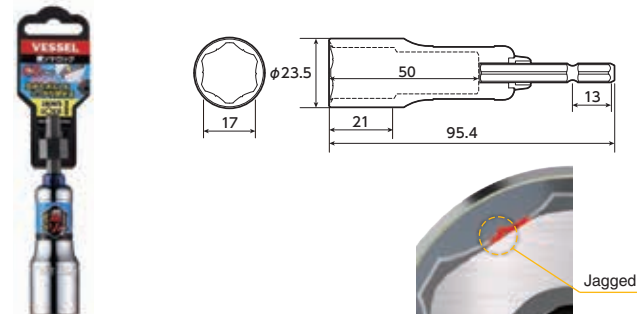

Code No.	Model No.	A/F	Outer Dia.	ℓ	Overall Length (mm)	Package size (mm)	JAN (4907587)
486275	MLS20179	17	23.5	21	95.4	150×35	028204

※The colors of the A/F column in the table indicate the seal colors. SPQ: 5 pcs. Outer Ctn.: 100 pcs.

Extra Long Socket

XA

- For tightening nuts to a long protrusion bolt.
- Convenient for duct mounting and hanging bolts.
- Surface contact dodecagonal socket.

RoHS

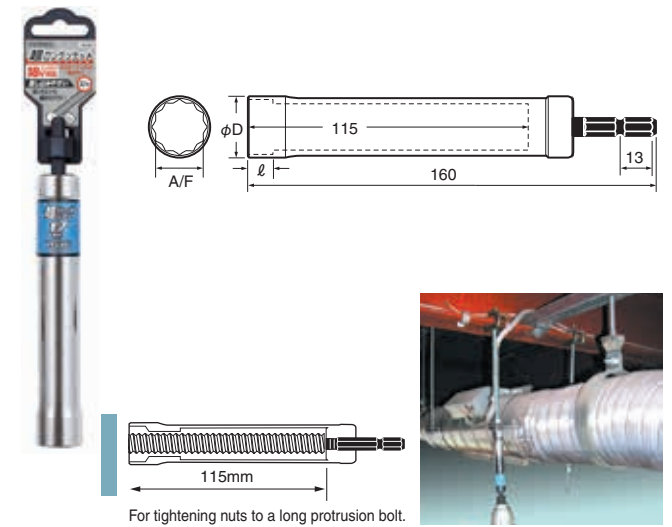

Code No.	Model No.	A/F	φD	ℓ	Overall Length (mm)	Package size (mm)	JAN (4907587)
486132	XA201715	17	23	9	160	217×35	345936
486133	XA201915	19	25	10	160	217×35	345943
486134	XA202115	21	28	11	160	217×35	345950
486131	XA202415	24	32	13	160	217×35	357694

※The colors of the A/F column in the table indicate the seal colors. SPQ: 5 pcs. Outer Ctn.: 50 pcs.

Drop-ceiling Socket

KA

- Super long deep hole type socket.
- The deep hole part of the socket has a diameter which is almost equal to the one of the full thread bolt. This design makes the socket light and easy to work upward.
- Surface contact dodecagonal socket.

RoHS

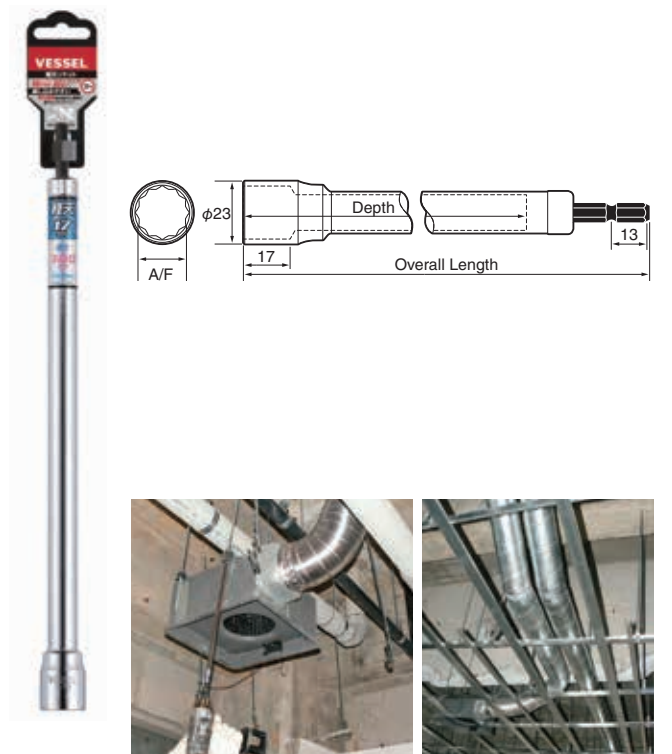

Code No.	Model No.	A/F	Outer Dia.	Depth	Overall Length (mm)	Package size (mm)	JAN (4907587)
484421	KA201730	17	23	255	300	355×35	357229
484422	KA201750	17	23	455	500	555×35	357236
484423	KA201770	17	23	655	700	755×35	357243

※The colors of the A/F column in the table indicate the seal colors. SPQ: 5 pcs.

HAND TOOLS

INDUSTRIAL BITS

CONSTRUCTION BITS

RECIPROCATING SAW BLADES

ELECTRIC TOOLS

AIR TOOLS

AIR NIPPERS

STATIC SOLUTIONS

GASOLINE ENGINE TOOLS

"GO-TAN" Socket

SA

- Most commonly used socket.
- Surface contact type hexagonal socket has excellent durability.

RoHS

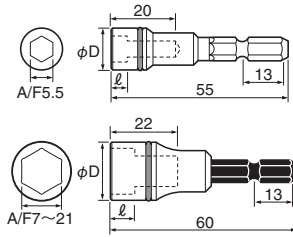

Axial Press-fitting is strong against twisting

Code No.	Model No.	A/F	φD	ℓ	Overall Length (mm)	Package size (mm)	JAN (4907587)
486230	SA205555	5.5	10	3.5	55	110×35	345806
486231	SA200755	7	13.5	5.5	60	115×35	345813
486232	SA200860	8	13.5	6.5	60	115×35	345820
486233	SA209660	9.6	15	6.5	60	115×35	345837
486234	SA201060	10	16	6.5	60	115×35	345844
486235	SA201260	12	18	8	60	115×35	345851
486236	SA201360	13	19	9	60	115×35	345868
486237	SA201460	14	20	8	60	115×35	345875
486238	SA201760	17	23	9	60	115×35	345882

※The colors of the A/F column in the table indicate the seal colors. SPQ: 5 pcs. Outer Ctn.: 100 pcs.

"GO-TAN" Socket Semi-Long type

SA

- Most commonly used socket.
- Surface contact type hexagonal socket has excellent durability.

RoHS

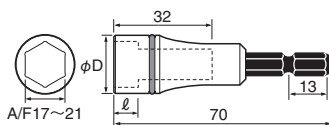

Code No.	Model No.	A/F	φD	ℓ	Overall Length (mm)	Package size (mm)	JAN (4907587)
486243	SA201770	17	23	9	70	125×35	345967
486239	SA201970	19	25	10	70	125×35	345899
486240	SA202170	21	28	11	70	125×35	345905

※The colors of the A/F column in the table indicate the seal colors. SPQ: 5 pcs. Outer Ctn.: 100 pcs.

Socket Bit Belt

BW-70

RoHS



Code No.	Model No.	Contents	Card size (mm)	JAN (4907587)
486705	BW-70	A/F 8×60 A/F 10×60 A/F 12×60 A/F 13×60 A/F 14×60 1pc. each	140×80×23	357755

Comes with one bit holder. SPQ: 5 sets

Socket for Plastic Cone

A201275

- For attaching and removing plastic cones.
- The shank can be hit with a hammer to remove concrete rubble.

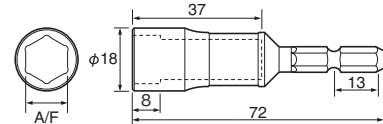

Code No.	Model No.	A/F	φD	Overall Length (mm)	Package size (mm)	JAN (4907587)
486241	A201275	12	18	72	120×35	345912

※The colors of the A/F column in the table indicate the seal colors. SPQ: 5 pcs. Outer Ctn.: 100 pcs.

Plastic Cone Catcher

A201275C

- A spring and a ball hold a plastic cone firmly, preventing plastic cone from coming out unexpectedly.

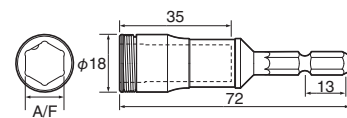

Code No.	Model No.	A/F	Outer Dia.	Overall Length (mm)	Package size (mm)	JAN (4907587)
486265	A201275C	12	18	72	130×35	358622

※The colors of the A/F column in the table indicate the seal colors. SPQ: 5 pcs. Outer Ctn.: 100 pcs.

HAND TOOLS
INDUSTRIAL BITS
CONSTRUCTION BITS
RECIPROCATING SAW BLADES
ELECTRIC TOOLS
AIR TOOLS
AIR NIPPERS
STATIC SOLUTIONS
GASOLINE ENGINE TOOLS

Rubble-removing Socket for Plastic Cones **A201210B**

- For attaching and removing plastic cones while removing concrete rubbles.
- Excellent abrasion-resistance with the highly hard cutting edge.

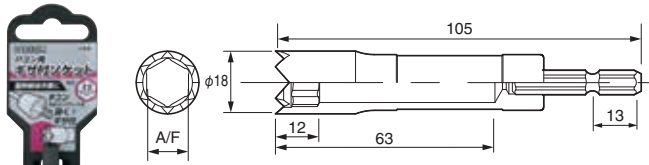

The socket part has a high hardness (51HRC), improving the wear resistance of the jagged part.



Code No.	Model No.	A/F	Outer Dia.	Overall Length (mm)	Package size (mm)	JAN (4907587)
486264	A201210B	12	18	105	160×35	358332

※The colors of the A/F column in the table indicate the seal colors.

SPQ: 5 pcs.

Ring Nut Setter **SAR**

- Ring spring holds the screw head firmly.
- Magnet is not used. No adhesion of chips.

RoHS

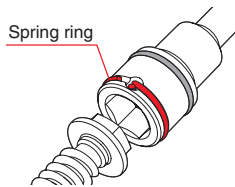
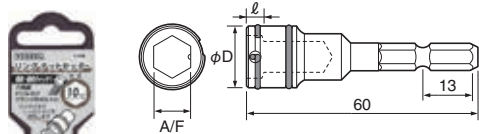

Code No.	Model No.	A/F	φD	ℓ	Overall Length (mm)	Package size (mm)	JAN (4907587)
486245	SAR0860	8	13	3	60	115×35	355980
486246	SAR9660	9.6	16	4	60	115×35	355997
486247	SAR1060	10	16	5	60	115×35	356000

※The colors of the A/F column in the table indicate the seal colors.

SPQ: 5 pcs. Outer Ctn.: 100 pcs.

Tilt Bit Holder **WBJ**

- Thanks to a hand-turned grip, users can work in a stable posture.
- For mounting of half-down hardware and angle brackets.
- Patented.

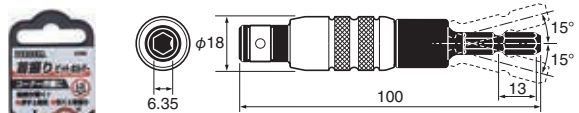

Code No.	Model No.	Bit mounting A/F	Outer Dia.	Overall Length (mm)	Package size (mm)	JAN (4907587)
486357	WBJ100	6.35	18	100	160×35	355959

SPQ: 5 pcs. Outer Ctn.: 100 pcs.

Long Bit Holder **EXJ**

- Insert 6.35mm hexagon bit, and transform it to a long type.
- Hand-turned grip enables to use in a stable posture.
- For tightening screws in high places or when nearby obstructions make work difficult.

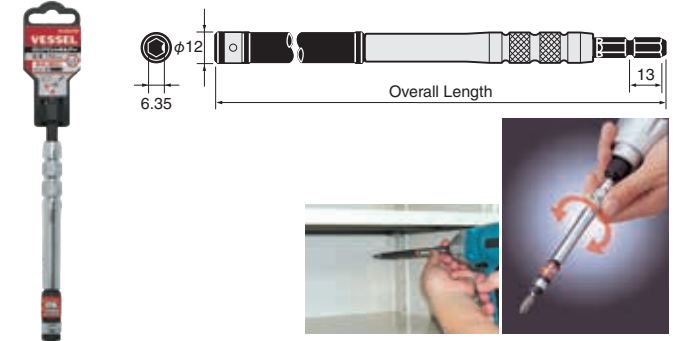

Code No.	Model No.	Bit mounting A/F	Outer Dia.	Overall Length (mm)	Package size (mm)	JAN (4907587)
486350	EXJ150	6.35	12	150	205×35	355966
486351	EXJ300	6.35	12	300	355×35	355973

EXJ150 SPQ: 5 pcs. Outer Ctn.: 100 pcs. EXJ300 SPQ: 5 pcs. Outer Ctn.: 50 pcs.

Slim Long Bit Holder **EXH NEW**

- φ13mm chuck enables to be inserted even into a narrow area.
- The pull-release sleeve chuck prevents mounted bits from dropping.
- Can be used with double end bit, socket, hex shank grinding stone, and brush.
- Fully hardened Extra Superalloy shank, resistant to twisting and bending.
- Anodized finish aluminum sleeve, resistant to chemicals. Color variations according to the size.

Extra Superalloy

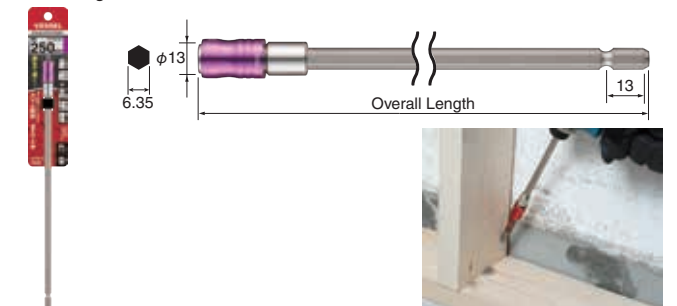

Code No.	Model No.	Bit mounting A/F	Outer Dia.	Overall Length (mm)	Package size (mm)	JAN (4907587)
486786	EXH-100	6.35	13	100	40×160	31501
486787	EXH-150	6.35	13	150	40×160	31518
486788	EXH-200	6.35	13	200	40×160	31525
486789	EXH-250	6.35	13	250	40×160	31532

EXH-100/150/200 SPQ: 5pcs Outer Ctn.: 100pcs EXH-250 SPQ: 5pcs Outer Ctn.: 50pcs

Slim Long Bit Holder DX **DXH NEW**

- φ13mm chuck enables to be inserted even into a narrow area.
- The pull-release sleeve chuck prevents mounted bits from dropping.
- Anodized finish aluminum sleeve, resistant to chemicals. Color variations according to the size.
- Can be used with double end bit, socket, hex shank grinding stone, and brush.
- Fully hardened Extra Superalloy shank, resistant to twisting and bending.
- φ8mm round shank. Less torque-loss.
- Rotating grip for holding the shank for stable and secured tightening.

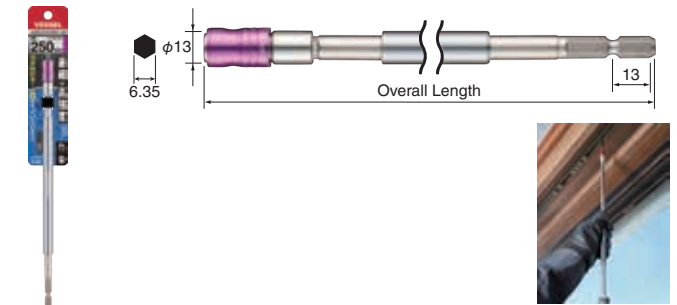

Code No.	Model No.	Bit mounting A/F	Outer Dia.	Overall Length (mm)	Package size (mm)	JAN (4907587)
486790	DXH-250	6.35	13	250	40×160	31549
486791	DXH-350	6.35	13	350	40×160	31556
486792	DXH-450	6.35	13	450	40×160	31563
486793	DXH-600	6.35	13	600	40×160	31570

DXH-250/350 SPQ: 5pcs Outer Ctn.: 50pcs DXH-450/650 SPQ: NIL Outer Ctn.: 5pcs

HAND TOOLS

INDUSTRIAL BITS

Universal Socket Adapter | A20USQ

- Universal adaptor used with a hand held socket.
- Most standard 9.5mm and 12.7mm socket types are available.
- Suitable for bolt and nut tightening works in narrow paces.

9.5 12.7

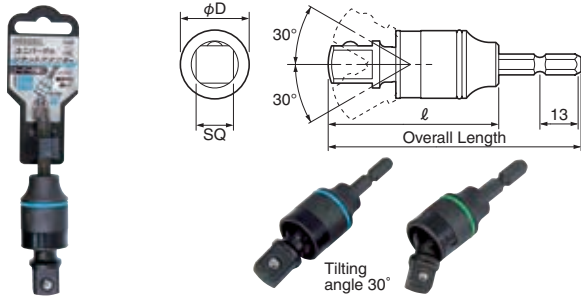

Code No.	Model No.	Socket mounting SQ	φD	l	Overall Length (mm)	Package size (mm)	JAN (4907587)
486268	A20USQ3	3/8" (9.5mm)	20	49	77	133×35	357205
486269	A20USQ4	1/2" (12.7mm)	23	56	84	140×35	357212

※The colors of the A/F column in the table indicate the seal colors. SPQ: 5 pcs. Outer Ctn.: 100 pcs.

"GO-TAN" Mirror Socket Adapter | TA20BSQ

- For sites where quick multiple tightening is required.
- Shock-absorbing resin has a torsion effect. 4 times more durable.
- Can be used with commercially available sockets.
- Patented.

9.5 12.7

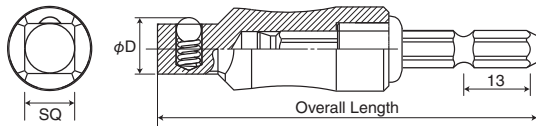

Code No.	Model No.	Socket mounting SQ	φD	Overall Length (mm)	Package size (mm)	JAN (4907587)
486494	TA20BSQ3L	9.5	16	110	170×35	359933
486495	TA20BSQ4L	12.7	18	115	175×35	359940

SPQ: 5 pcs. Outer Ctn.: 100 pcs.

"GO-TAN" Tilt Mirror Socket Adapter | TA20WSQ

- Pull the hex shank to tilt 15 degrees and push it to fix.
- For a place such as around-corners, where it is difficult to work with impact drivers.
- Shock-absorbing resin has a torsion effect. 4 times more durable.
- Can be used with commercially available sockets.
- Patented.

9.5 12.7

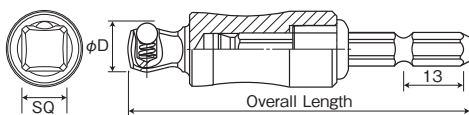

Code No.	Model No.	Socket mounting SQ	φD	Overall Length (mm)	Package size (mm)	JAN (4907587)
486496	TA20WSQ3	9.5	16	72	130×35	359957
486498	TA20WSQ3L	9.5	16	110	170×35	359971
486499	TA20WSQ4L	12.7	18	115	175×35	359988

SPQ: 5 pcs. Outer Ctn.: 100 pcs.

CONSTRUCTION BITS

RECIPROCATING SAW BLADES

ELECTRIC TOOLS

AIR TOOLS

AIR NIPPERS

STATIC SOLUTIONS

GASOLINE ENGINE TOOLS

"GO-TAN" Tilt Mirror Socket Adapter & Short Socket Set | TA20WSQ3-11PS

- Pull the hex shank to tilt 15 degrees and push it to fix.
- For a place such as around-corners, where it is difficult to work with impact drivers.
- Shock-absorbing resin has a torsion effect. 4 times more durable.
- Can be used with commercially available sockets.
- Patented.

9.5



Code No.	Model No.	Set contents	Case size (mm)	JAN (4907587)
486273	TA20WSQ3-11PS	"GO-TAN" Tilt Mirror Socket Adapter 9.5mm (OAL: 72, 115 mm): 1 each Short sockets: A/F8, 10, 13, 14, 17, 19, 21, 22, 24	105×227	012722

Outer Ctn.: 20 sets

"GO-TAN" Tilt Adapter & Short Socket Set | TA20WSQ4-11PS

- Pull the hex shank to tilt 15 degrees and push it to fix.
- For a place such as around-corners, where it is difficult to work with impact drivers.
- Shock-absorbing resin has a torsion effect. 4 times more durable.
- Can be used with commercially available sockets.
- Patented.

12.7



Code No.	Model No.	Set contents	Case size (mm)	JAN (4907587)
486274	TA20WSQ4-11PS	"GO-TAN" Tilt Mirror Socket Adapter 12.7mm (OAL: 77, 115mm): 1 each Short sockets: A/F8, 10, 13, 14, 17, 19, 21, 22, 24	105×227	012739

Outer Ctn.: 20 sets

Super Hard Forged Mirror Socket Adapter **MTA20BSQ**

- 5 times more durable! The shaft is integrally molded with resin and press-fitted to reduce the concentrated stress on the shaft during impact. **9.5 12.7 RoHS**
- Can be used with wrench sockets.
- Patented.

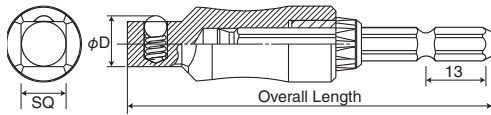

Code No.	Model No.	Socket mounting SQ	phi D	Overall Length (mm)	Package size (mm)	JAN (4907587)
485071	MTA20BSQ3	9.5	16	77	135×35	026798
485072	MTA20BSQ4	12.7	18	82	140×35	026804
485073	MTA20BSQ3L	9.5	16	110	165×35	026811
485074	MTA20BSQ4L	12.7	18	115	170×35	026828

SPQ: 5 pcs. Outer Ctn.: 100 pcs.

Super Hard Forged Tilt Mirror Socket Adapter **MTA20WSQ**

- Pull the hex shank to tilt 15 degrees and push it to fix. **9.5 12.7 RoHS**
- 5 times more durable! The shaft is integrally molded with resin and press-fitted to reduce the concentrated stress on the shaft during impact.
- Can be used with wrench sockets.
- Patented.

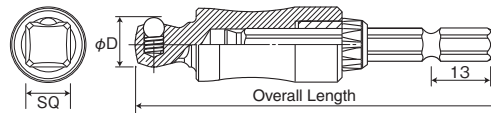

Code No.	Model No.	Socket mounting SQ	phi D	Overall Length (mm)	Package size (mm)	JAN (4907587)
485075	MTA20WSQ3	9.5	16	77	135×35	026835
485076	MTA20WSQ4	12.7	18	82	140×35	026842
485077	MTA20WSQ3L	9.5	16	110	165×35	026859
485078	MTA20WSQ4L	12.7	18	115	170×35	026866

SPQ: 5 pcs. Outer Ctn.: 100 pcs.

Socket Adapter **A20BSQ**

- Adapter allowing to use a socket that you have. **6.35 9.5 12.7**
- 3 sizes available depending on the socket mounting size.
- 3/8", 1/2" models: Improved durability by press-fitting.

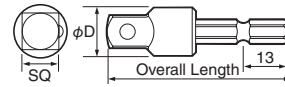

Code No.	Model No.	Socket mounting SQ	phi D	Overall Length (mm)	Package size (mm)	JAN (4907587)
486352	A20BSQ2	1/4" (6.35mm)	8	45	105×35	355904
486353	A20BSQ3	3/8" (9.5mm)	14	54	112×35	355911
486354	A20BSQ4	1/2" (12.7mm)	16	59	117×35	355928

SPQ: 5 pcs. Outer Ctn.: 100 pcs.

Tilt Socket Adapter **A20WSQ**

- Adapter allowing to use a socket that you have. **9.5 12.7**
- Pull the product to tilt, and push it to fix.
- Improved durability by press-fitting.
- Patented.

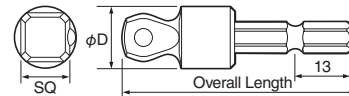

Code No.	Model No.	Socket mounting SQ	phi D	Overall Length (mm)	Package size (mm)	JAN (4907587)
486355	A20WSQ3	3/8" (9.5mm)	14	56	114×35	355935
486356	A20WSQ4	1/2" (12.7mm)	16	60	117×35	355942

SPQ: 5 pcs. Outer Ctn.: 100 pcs.

Socket Adapter w/Hex Bolster for 220USB (Type-A bit) **USBBSQ NEW**

- Bit holder that can also be used with the 220USB (Type-A bit).
- The hexagonal bolster can be handled with 10mm wrench.

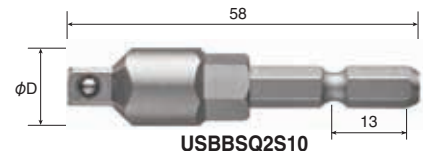

USBBSQ2S10

USBBSQ2S10 USBBSQ3S10



USBBSQ3S10

Code No.	Model No.	Hex bolster Width A/F (mm)	Socket mounting SQ	phi D (mm)	Card size (mm)	JAN (4907587)
485809	USBBSQ2S10	10	1/4	13	160×35×15	030689
485810	USBBSQ3S10	10	3/8	13	160×35×15	030696

SPQ: 10 pcs.

Form Tie Socket (For Ivy Form Ties) | A202110F

- Ivy foam ties and nuts can be removed at the same time.
- Surface contact dodecagonal socket.

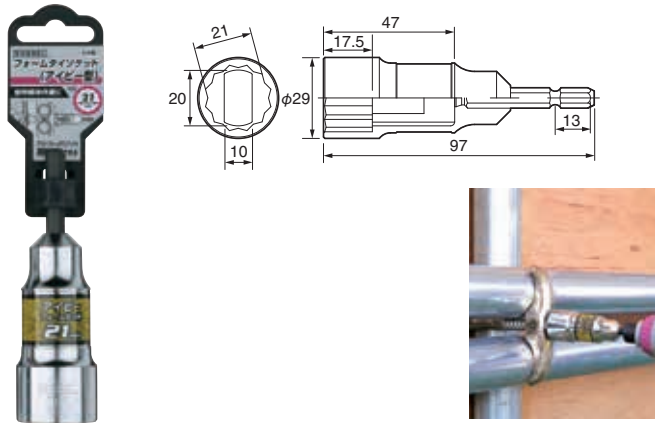

Code No.	Model No.	A/F	Outer Dia.	Overall Length (mm)	Package size (mm)	JAN (4907587)
486267	A202110F	21	29	97	160×35	358349

※The colors of the A/F column in the table indicate the seal colors. SPQ: 5 pcs. Outer Ctn.: 100 pcs.

Thread Thru Stud Socket | A20ZW

- 3 rollers hold the thread stud firmly.
- Indispensable for a work with hanging bolts and light gauge steel framing construction.

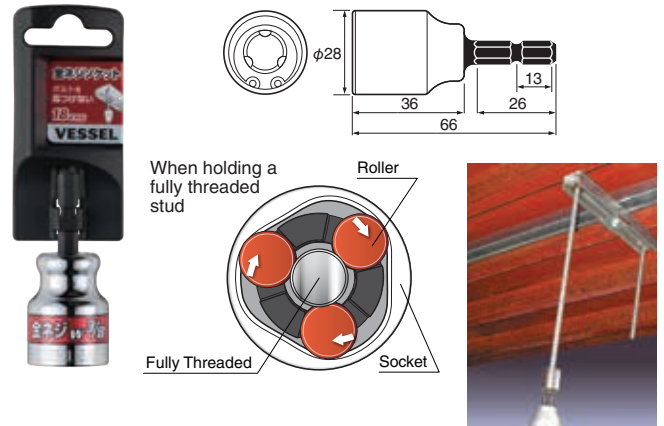

Code No.	Model No.	Thread Size	Outer Dia.	Overall Length (mm)	Package size (mm)	JAN (4907587)
486359	A20ZW30	w3/8	28	66	124×38×28	346780
486360	A20ZW40	w1/2	28	66	124×38×28	346797

※The colors of the Screw size column in the table indicate the seal colors. SPQ: 5 pcs. Outer Ctn.: 100 pcs.

Form Tie Socket | GA20F101

- Suitable for both K type form tie and Ivy form tie.
- Socket exclusively for form ties.

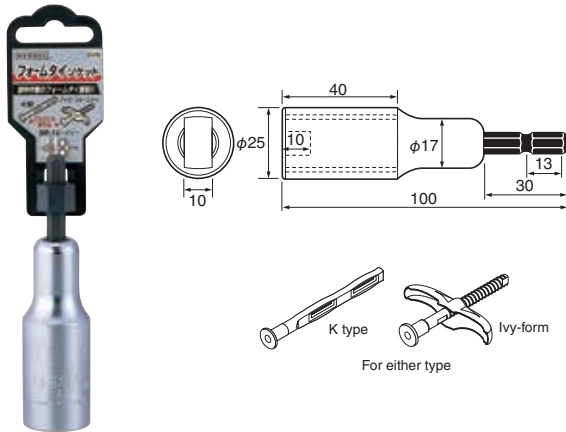

Code No.	Model No.	A/F	Outer Dia.	Overall Length (mm)	Package size (mm)	JAN (4907587)
486491	GA20F101	10	25	100	160×35	346704

SPQ: 5 pcs. Outer Ctn.: 100 pcs.

Thumbscrew Socket | A20CH13

- Recommended to farmers!
- This single socket enables to tighten both thumbscrews and hexagonal nuts.

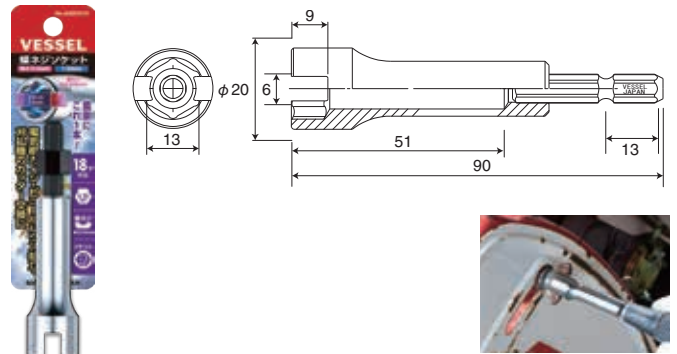

Code No.	Model No.	A/F	φD	Overall Length (mm)	Package size (mm)	JAN (4907587)
486244	A20CH13	13	20	90	140×35	347404

SPQ: 5 pcs. Outer Ctn.: 100 pcs.

HAND TOOLS
INDUSTRIAL BITS
CONSTRUCTION BITS
RECIPROCATING SAW BLADES
ELECTRIC TOOLS
AIR TOOLS
AIR NIPPERS
STATIC SOLUTIONS
GASOLINE ENGINE TOOLS

Magnetic Screw Catcher

BH

- When a screw is close to the product, the magnetic sleeve automatically moves to catch it.
- Ideal for floorboards, joists, interiors, 2x4s, and other construction-related work.

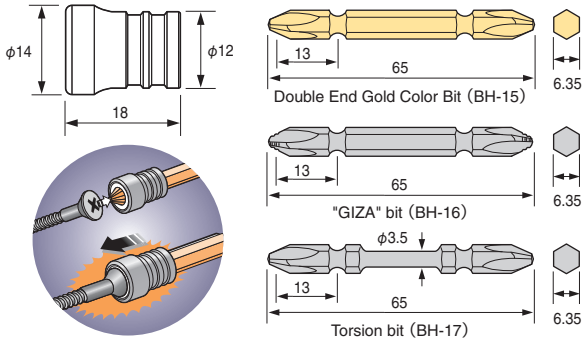

Automatically catches screws



BH-15 BH-16 BH-17



Code No.	Model No.	Set contents	Card size (mm)	JAN (4907587)
486331	BH-15	Magnetic Screw Catch 1pc. Double End Gold Color Bit $\Phi 2 \times 65$ 1pc.	135×45	354884
486332	BH-16	Magnetic Screw Catch 1pc. "GIZA" bit $\Phi 2 \times 65$ 1pc.	135×45	354891
486333	BH-17	Magnetic Screw Catch 1pc. Torsion bit $\Phi 2 \times 65$ 1pc.	135×45	354907

SPQ: 10 pcs.

Screw Catch and Adjuster

BH-11

- Catches long screws even without magnetic force.
- Screw stopper function keeps the level of screw head constant, causing no damage to the plaster board.

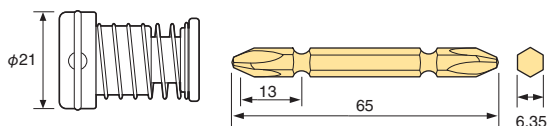

Start tightening

Complete tightening!

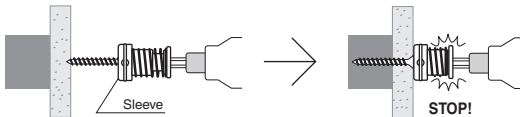

8~9.5mm

 Can be used with bell-shaped screws.



Code No.	Model No.	Set contents	Card size (mm)	JAN (4907587)
486324	BH-11	Screw Catch and Adjuster 1pc. Double End Gold Color Bit $\Phi 2 \times 65$ 1pc.	135×45	347053

SPQ: 10 pcs.

Strong Magnet Catcher

SMBC NEW

- Strong neodymium magnet built-in. Can securely catch long screws.
- When a screw head is brought close to the catcher part, it automatically moves by magnetic force and catches the screw.
- The slim shape makes it easy to see the tip-end of the bit and insert it into the screw head recess.



SMBC-1PR SMBC-1PB



Code No.	Model No.	Set contents	Card size (mm)	JAN (4907587)
487041	SMBC-1PR	Strong Magnet Catcher (Red)	120×35×13	029140
487042	SMBC-1PB	Strong Magnet Catcher (Blue)	120×35×13	029157

SPQ: 10 sets

Strong Magnet Catcher w/Bit

SMBC14 NEW

- Set of Strong magnet catcher and a double end bit ($\Phi 2 \times 65$).
- Strong neodymium magnet built-in. Can securely catch long screws.
- When a screw head is brought close to the catcher part, it automatically moves by magnetic force and catches the screw.
- The slim shape makes it easy to see the tip-end of the bit and insert it into the screw head hole.



Code No.	Model No.	Set contents	Card size (mm)	JAN (4907587)
485460	SMBC142065	Double end bit ($\Phi 2 \times 65$), Strong magnet catcher (Red)	135×35×15	028600

SPQ: 5 sets

HAND TOOLS

INDUSTRIAL BITS

CONSTRUCTION BITS

RECIPROCATING SAW BLADES

ELECTRIC TOOLS

AIR TOOLS

AIR NIPPERS

STATIC SOLUTIONS

GASOLINE ENGINE TOOLS

■ 9.5 / 12.7 mm Adapter for Impact Wrenches

Socket Anvil

A30

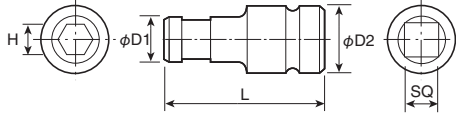

Code No.	Model No.	SQ x H (mm)	Dimensions (mm)			Applicable to	JAN (4907587)
			D1	D2	L		
479201	A30	9.5×6.35	13	20	45	A14·A16	340177
479202		9.5×8.0	16	20	47.5	A15·A19	340184
479401		12.7×6.35	13	25	49	A14·A16	340191
479402		12.7×8.0	16	25	51	A15·A19	341204

■ 12.7 mm Adapter for Impact Wrenches

Socket Anvil

BH-30

- Adapter for air/electric impact wrenches.
- H6.35mm bit can be mounted by a ball locking system.



Code No.	Model No.	Socket Mounting x Width A/F (mm)	Card size (mm)	JAN (4907587)
486336	BH-30	12.7×6.35	135×60	355249

SPQ: 5 pcs.

Socket Anvil (sleeve type)

BHC-30

- Adapter for air/electric impact wrenches.
- H6.35mm bit can be mounted by one-touch action.

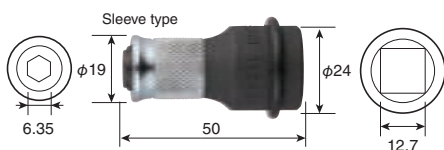

Code No.	Model No.	Socket Mounting x Width A/F (mm)	Card size (mm)	JAN (4907587)
486582	BHC-30	12.7×6.35	135×60	358639

SPQ: 5 pcs.

Torsion Bit Holder

BH-14

- Bit holder with a torsion part.
- Can be used by mounting a double-ended bit.
- Prevents screw stripping and bit breakage.

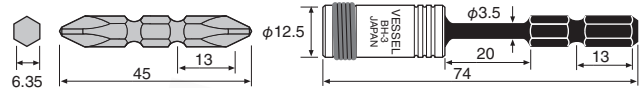

Assuredly holds bit with ball and spring.

Torsion shank absorbs impact.



Code No.	Model No.	Contents	Card size (mm)	JAN (4907587)
486330	BH-14	Torsion Bit Holder 1pc. High Hardness Bit φ2×45 1pc.	160×45	354792

SPQ: 10 pcs.

Bit Holder w/Hex Bolster | USBBH1S10 NEW

- Bit holder that can also be used with the 220USB (Type-A bit).
- The hexagonal bolster can be handled with 10mm wrench.

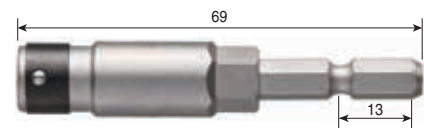

Code No.	Model No.	Hex bolster Width A/F (mm)	Bit mounting (mm)	Outer Dia. (mm)	Card size (mm)	JAN (4907587)
485808	USBBH1S10	10	6.35	φ13	160×35×15	030672

SPQ: 10 pcs.

HAND TOOLS

INDUSTRIAL BITS

CONSTRUCTION BITS

RECIPROCATING SAW BLADES

ELECTRIC TOOLS

AIR TOOLS

AIR NIPPERS

STATIC SOLUTIONS

GASOLINE ENGINE TOOLS

Pin Wrench for Disk Nut | A202050P

- Can be used with an electric impact driver to remove firmly tightened disk nuts easily.
- For the disk grinder with the wheel diameter of 100mm.

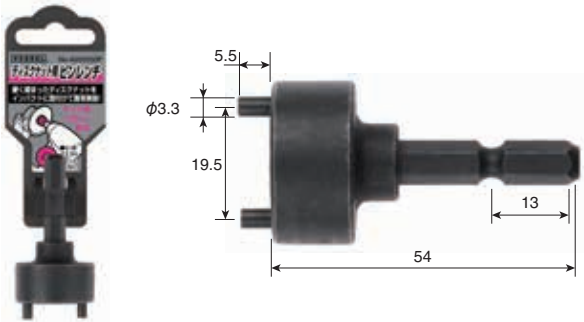

Code No.	Model No.	Nut Hole Pitch	Pin Dia. ϕ	Package size (mm)	JAN (4907587)
486581	A202050P	19.5	3.3	107×35	358653

SPQ: 5 pcs.

ONE POINT | A202050P

Remove a disk nut easily...



Pin wrench for a disk nut with A/F6.35mm drive that can be used with a rechargeable impact driver. Remove a disk nut easily that was difficult with a provided wrench.



ONE POINT

Various applications of socket bits

	For assembly and disassembly of electric appliances, hex tapping screws, and bolt and nut tightening	→	5.5 mm
	For mounting casters and adjust bolts, and pipe saddles to ALC, etc.	→	7 mm
	For corrugated panels (hook bolts), folded plate roof materials, and drill screws to be used between roof frames, etc.	→	8 mm
	For mounting fixtures to C-shape steel (drill screws, etc.)	→	9.6 mm
	For corrugated panels (hook bolts), steel furniture assembly, lag screws, etc.	→	10 mm
	For corrugated slate panels (hook bolts), form work equipment (plastic cones), etc.	→	12 mm
	For mounting members to cavity walls (hanger bolts for cavity walls), lag screws, facility, piping work, etc.	→	13 mm
	For placing folded plate roof (roof bolts), duct mounting, facility, piping work, etc.	→	14 mm
	For scaffolding work (clamps), cable rack assembly, lag screws, etc.	→	17 mm
	For strap bolts, lag screws, etc.	→	19 mm
	For form tie nuts, strap bolts, lag screws, etc.	→	21 mm
	Useful when concrete is attached to a form tie nut	→	22 mm
	For hall-down joint metals (bolt with washer, anchor bolt), etc.	→	24 mm

HAND TOOLS

INDUSTRIAL BITS

CONSTRUCTION BITS

RECIPROCATING SAW BLADES

ELECTRIC TOOLS

AIR TOOLS

AIR NIPPERS

STATIC SOLUTIONS

GASOLINE ENGINE TOOLS

AMD

Cushion Drill Bit

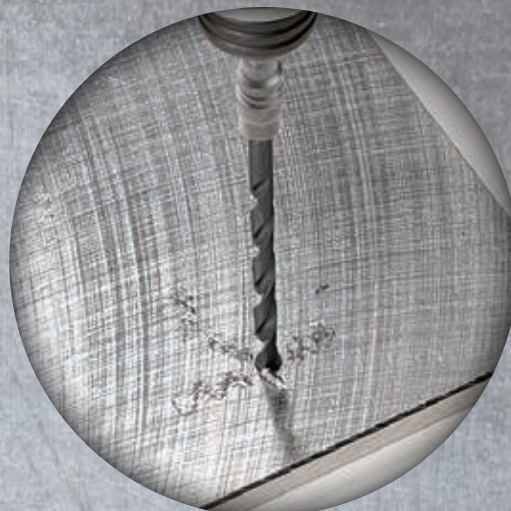

The unique cushion ring for drilling holes at the targeted points. The cushion ring stops rattling of the ball groove and reduces runout to the rotating direction. The X-shape thinning tip-end allows slipless drilling on curved surfaces with light force, not using a center punch.

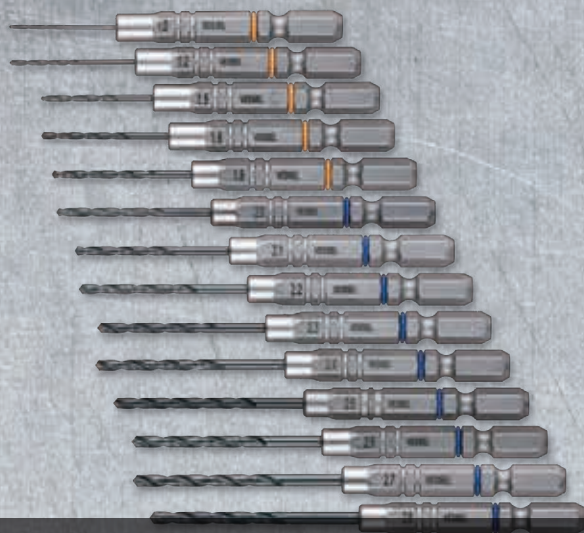

High hardness HSS keeps the tip-end sharp.



AMD Cushion Drill Bit (for steel)

For various drillings in iron, light metals, synthetic resins, wood, etc., and for drilling holes for tapping.

X-shape (cross) thinning tip-end allows high speed drilling. Remarkable fitting.

※AMD-3.0 or bigger
Drilling with light force, not using a center punch.



The different color for each size. Easy to find.



HAND TOOLS
INDUSTRIAL BITS
CONSTRUCTION BITS
RECIPROCATING SAW BLADES
ELECTRIC TOOLS
AIR TOOLS
AIR NIPPERS
STATIC SOLUTIONS
GASOLINE ENGINE TOOLS

Cushion Drill Bit (for steel) | AMD

- For various drilling work with iron, light metals, synthetic resins, wood, etc., and for drilling holes for tapping.
- High hardness HSS (HSS steel) keeps sharpness.

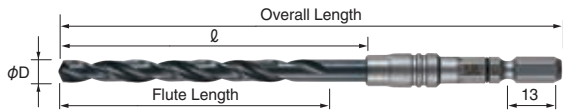

X-shape (cross) thinning process enables high-speed drilling and remarkable fitting.



※AMD-3.0 or bigger
Drilling with light force, not using a center punch.

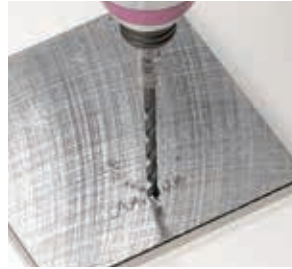

Code No.	Model No.	φD	ℓ	Flute Length	Overall Length(mm)	Card size (mm)	JAN (4907587)
461111	AMD-1.0	1.0	22	12	72	165×35×12	602657
461112	AMD-1.2	1.2	26	16	76	165×35×12	602664
461113	AMD-1.5	1.5	24	18	74	165×35×12	602671
461114	AMD-1.6	1.6	26	20	76	165×35×12	602688
461115	AMD-1.8	1.8	29	22	79	165×35×12	602695
461001	AMD-2.0	2.0	32	24	82	165×35×12	600011
461116	AMD-2.1	2.1	32	24	82	165×35×12	602701
461117	AMD-2.2	2.2	36	27	86	165×35×12	602718
461118	AMD-2.3	2.3	36	27	86	165×35×12	602725
461119	AMD-2.4	2.4	40	30	90	165×35×12	602732
461002	AMD-2.5	2.5	40	30	90	165×35×12	600028
461120	AMD-2.6	2.6	40	30	90	165×35×12	602749
461121	AMD-2.7	2.7	44	33	94	165×35×12	602756
461003	AMD-2.8	2.8	44	33	94	165×35×12	600035
461122	AMD-2.9	2.9	44	33	94	165×35×12	602763
461004	AMD-3.0	3.0	44	33	94	165×35×12	600042
461123	AMD-3.1	3.1	44	36	94	165×35×12	602770
461005	AMD-3.2	3.2	48	36	98	165×35×12	600059
461006	AMD-3.3	3.3	48	36	98	165×35×12	600066
461017	AMD-3.4	3.4	53	39	103	165×35×12	600172
461007	AMD-3.5	3.5	53	39	103	165×35×12	600073
461018	AMD-3.6	3.6	53	39	103	165×35×12	600189
461008	AMD-3.7	3.7	53	39	103	165×35×12	600080
461009	AMD-3.8	3.8	58	43	108	165×35×12	600097
461124	AMD-3.9	3.9	58	43	108	165×35×12	602787
461010	AMD-4.0	4.0	58	43	108	165×35×12	600103
461125	AMD-4.1	4.1	58	43	108	165×35×12	602794
461011	AMD-4.2	4.2	58	43	108	165×35×12	600110
461019	AMD-4.3	4.3	63	47	113	165×35×12	600196
461126	AMD-4.4	4.4	63	47	113	165×35×12	602800
461012	AMD-4.5	4.5	63	47	114	165×35×12	600127
461127	AMD-4.6	4.6	64	47	114	165×35×12	602817
461128	AMD-4.7	4.7	64	47	114	165×35×12	602824
461013	AMD-4.8	4.8	69	52	120	165×35×12	600134
461129	AMD-4.9	4.9	70	52	120	165×35×12	602831
461014	AMD-5.0	5.0	69	52	120	165×35×12	600141
461020	AMD-5.2	5.2	69	52	120	165×35×12	600202
461015	AMD-5.5	5.5	76	57	127	165×35×12	600158
461130	AMD-5.8	5.8	77	57	127	165×35×12	602848
461016	AMD-6.0	6.0	76	57	127	165×35×12	600165

※Colors inside the table indicate the ring color.

1pc./pack SPQ: 10 pcs, Outer Ctn.: 200 pcs

Cushion Drill Bit (for steel), 3-pc set | AMD3S



Code No.	Model No.	Contents	Card size (mm)	JAN (4907587)
461101	AMD3S-1	2.0 / 2.5 / 3.0mm 1pc each	165×50×10	602305
461102	AMD3S-2	3.0 / 3.5 / 4.0mm 1pc each	165×50×10	602312
461103	AMD3S-3.5	3.5mm 3pcs.	165×50×10	602329
461089	AMD3S-2.0	2.0mm 3pcs.	165×45×10	007759
461090	AMD3S-2.5	2.5mm 3pcs.	165×45×10	007766
461091	AMD3S-2.8	2.8mm 3pcs.	165×45×10	007773
461092	AMD3S-3.0	3.0mm 3pcs.	165×45×10	007780
461093	AMD3S-3.2	3.2mm 3pcs.	165×45×10	007797
461094	AMD3S-3.3	3.3mm 3pcs.	165×45×10	007803
461095	AMD3S-3.8	3.8mm 3pcs.	165×45×10	007810
461096	AMD3S-4.0	4.0mm 3pcs.	165×45×10	007827
461097	AMD3S-4.2	4.2mm 3pcs.	165×45×12	007834
461098	AMD3S-4.5	4.5mm 3pcs.	165×45×12	007841
461099	AMD3S-5.0	5.0mm 3pcs.	165×45×12	007858
461100	AMD3S-6.0	6.0mm 3pcs.	165×45×12	007865

SPQ: 10 sets Outer Ctn.: 120 sets

Cushion Drill Bit (for steel), 6-pc set | AMD6P



AMD6P AMD6P AMD6P AMD6P AMD6P AMD6P
-2.5 -3.0 -3.2 -3.3 -3.5 -4.0

NEW
NEW
NEW
NEW

Code No.	Model No.	Contents	Package size (mm)	JAN (4907587)
461171	AMD6P-2.5	2.5mm 6pcs.	165×50×7	027702
461172	AMD6P-3.0	3.0mm 6pcs.	165×50×7	027719
461173	AMD6P-3.2	3.2mm 6pcs.	165×50×7	027726
461174	AMD6P-3.3	3.3mm 6pcs.	165×50×7	027733
461104	AMD6P-3.5	3.5mm 6pcs.	165×50×7	602336
461175	AMD6P-4.0	4.0mm 6pcs.	165×50×7	027740

SPQ: 10 sets Outer Ctn.: 120 sets

Cushion Drill Bit (for steel), 7-pc set | AMD7S



Code No.	Model No.	Contents	Package size (mm)	JAN (4907587)
461105	AMD7S	φD 2.8, 3.0, 3.5, 4.2, 4.5, 5.0, 6.0mm (1 each)	175×65×10	005854

SPQ: 5 sets Outer Ctn.: 100 sets

Cushion Drill Bit (for steel), 14-pc set | AMD14S



Code No.	Model No.	Contents	Case size (mm)	JAN (4907587)
461106	AMD14S	φD 1.5, 2.0, 2.5, 2.8, 3.0, 3.2, 3.5, 4.0, 4.5, 5.0, 5.5, 6.0, 6.5, 7.0mm (1 each)	155×108×38	006066

*φD6.5/7.0 are "KESSAKU" drill bit (No.KMD). Outer Ctn.: 10 sets

"KESSAKU" Drill Bit | KMD

- The irregular spiral with different angles between the tip and the shank side discharge chips smoothly and improves workability.
- X-shape thinning can fit the point to drill and the pilot hole punching is not required.

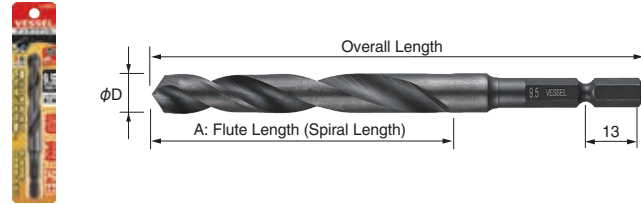

Code No.	Model No.	φD	A	Overall Length (mm)	Card size (mm)	Inner Ctn.	Outer Ctn.	JAN (4907587)
461141	KMD-6.5	6.5	63	107	165×35×11	10	200	602916
461142	KMD-7.0	7.0	65	109	165×35×11	10	200	602923
461143	KMD-7.5	7.5	66	110	165×35×11	10	200	602930
461144	KMD-8.0	8.0	67	111	165×35×11	10	200	602947
461145	KMD-8.5	8.5	70	114	165×35×11	10	200	602954
461146	KMD-9.0	9.0	73	117	165×35×11	10	200	602961
461147	KMD-9.5	9.5	74	118	165×35×15	5	100	602978
461148	KMD-10.0	10.0	76	120	165×35×15	5	100	602985
461149	KMD-10.5	10.5	78	122	165×35×15	5	100	602992
461150	KMD-11.0	11.0	81	125	165×35×15	5	100	603005
461151	KMD-11.5	11.5	82	126	165×35×15	5	100	603012
461152	KMD-12.0	12.0	83	127	165×35×15	5	100	603029
461153	KMD-12.5	12.5	83	128	165×35×15	5	100	603036
461154	KMD-13.0	13.0	85	130	165×35×15	5	100	603043

1pc./pack

ONE POINT | KMD

Drill a large bore hole with "KESSAKU" drill bit.

Irregular spiral shape

While making a hole, high speed revolution of power tool may cause the machined chips to block the drilled hole and, in consequence, the product cannot be drilled through. In order to let out the chips sequentially, the tip-end of the drill adopts an irregular spiral shape in its design. The spiral angle turns to be more moderate in the drive side. This design enables to make the drilling work quicker by exhausting the machined chips efficiently.



Cushion Drill Bit for Porcelain Tiles | APD

- Slipless quick drilling.
- Special carbide chip for porcelain tiles is attached at the bit tip with heat-resistant solder.
- Cushion ring prevents backlash, enabling to drill at the right point.

RoHS

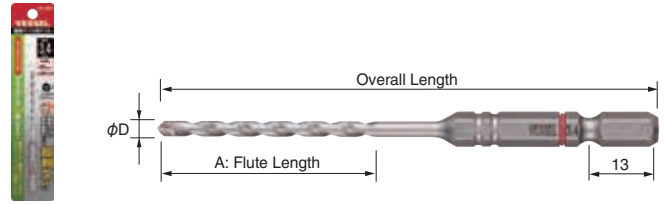

Code No.	Model No.	φD	A	Overall Length (mm)	Card size (mm)	JAN (4907587)
464001	APD-3.0	3.0	45	102	165×35×12	006899
464002	APD-3.2	3.2	45	102	165×35×12	006905
464003	APD-3.4	3.4	45	102	165×35×12	006912
464004	APD-3.5	3.5	45	102	165×35×12	006929
464005	APD-3.8	3.8	50	107	165×35×12	006936
464006	APD-4.0	4.0	50	107	165×35×12	006943
464007	APD-4.3	4.3	50	107	165×35×12	006950
464008	APD-4.5	4.5	50	107	165×35×12	006967
464009	APD-4.8	4.8	50	107	165×35×12	006974
464010	APD-5.0	5.0	50	107	165×35×12	006981
464011	APD-5.3	5.3	65	122	165×35×12	006998
464012	APD-5.5	5.5	65	122	165×35×12	007001
464013	APD-6.0	6.0	65	122	165×35×12	007018
464014	APD-6.4	6.4	65	122	165×35×12	007025
464015	APD-6.5	6.5	65	122	165×35×12	007032

*Colors inside the table indicate 1pc./pack SPQ: 10 pcs, Outer Ctn.: 200 pcs the ring color.

Cushion Drill Bit for Porcelain Tiles, 3-pc set | APD3S



RoHS

Code No.	Model No.	Contents	Card size (mm)	JAN (4907587)
464016	APD3S-3.4	3.4mm 3pcs.	165×50×10	007049
464017	APD3S-3.5	3.5mm 3pcs.	165×50×10	007056
464018	APD3S-4.3	4.3mm 3pcs.	165×50×10	007063
464019	APD3S-6.0	6.0mm 3pcs.	165×50×10	007070

*Colors inside the table indicate the ring color. Inner Ctn.: 10 sets

ONE POINT | APD

Outstanding durability and machining speed



Special tip-end design, with drilling capability on porcelain tiles taken into consideration, enables to drill quickly. Carbide chip is soldered at the tip-end. Asymmetric tip-end reduces the machining resistance, resulting in a quick drilling with a low torque even on a hard and slippery porcelain tile.



Heat resistant solder makes the bit highly endurable even without using water when drilling. Endurable soldering material is chosen for attachment of the carbide chip to the tip-end of the bit, and thus water is not always required. However, using the APD drill bit with water at its tip-end can improve the lifetime.

Different colors applied to each size. Can find easily the bit that you need.
 φ3.0~3.8mm = Red
 φ4.0~4.8mm = Yellow
 φ5.0~5.5mm = Green
 φ6.0~6.5mm = Black



Cushion ring prevents the bit from rattling and allows to drill at the targeted points. VESSEL's unique cushion ring reduces rattling of the bit in a chuck. In harmony with the tip-end fitting, this enables to drill a hole reliably at the targeted points.

HAND TOOLS

INDUSTRIAL BITS

CONSTRUCTION BITS

RECIPROCATING SAW BLADES

ELECTRIC TOOLS

AIR TOOLS

AIR NIPPERS

STATIC SOLUTIONS

GASOLINE ENGINE TOOLS

Cushion Drill Bit (for concrete) | ACD

● Drilling holes on mortar, block, brick, ALC, plaster boards, etc. and also drilling pilot holes for screw anchor insertion and plugless screws. RoHS

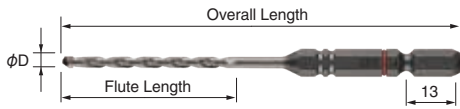

Carbide Tipped
+
Asymmetry shape



This asymmetry shaped tip reduces the cutting resistance, making it possible to drill at a relatively low torque.



Code No.	Model No.	φD	Flute Length	Overall Length	(mm)	Card size (mm)	JAN (4907587)
462001	ACD-3.0	3.0	45	102	165×35×12	601018	
462002	ACD-3.2	3.2	45	102	165×35×12	601025	
462003	ACD-3.4	3.4	45	102	165×35×12	601032	
462004	ACD-3.5	3.5	45	102	165×35×12	601049	
462005	ACD-3.8	3.8	50	107	165×35×12	601056	
462006	ACD-4.0	4.0	50	107	165×35×12	601063	
462007	ACD-4.3	4.3	50	107	165×35×12	601070	
462008	ACD-4.5	4.5	50	107	165×35×12	601087	
462009	ACD-4.8	4.8	50	107	165×35×12	601094	
462010	ACD-5.0	5.0	50	107	165×35×12	601100	
462015	ACD-5.3	5.3	65	122	165×35×12	601155	
462011	ACD-5.5	5.5	65	122	165×35×12	601117	
462012	ACD-6.0	6.0	65	122	165×35×12	601124	
462013	ACD-6.4	6.4	65	122	165×35×12	601131	
462014	ACD-6.5	6.5	65	122	165×35×12	601148	

※Colors inside the table indicate the ring color. 1pc./pack SPQ: 10 pcs, Outer Ctn.: 200 pcs

Cushion Drill Bit (for concrete) Long Type | ACD



RoHS

Code No.	Model No.	φD	Flute Length	Overall Length	(mm)	Card size (mm)	JAN (4907587)
462029	ACD-3.4L	3.4	95	152	200×35×12	601346	
462030	ACD-3.5L	3.5	95	152	200×35×12	601353	
462031	ACD-4.3L	4.3	100	157	200×35×12	601315	
462032	ACD-4.8L	4.8	100	157	200×35×12	601322	
462033	ACD-5.0L	5.0	100	157	200×35×12	601339	
462034	ACD-6.4L	6.4	115	172	200×35×12	601360	

※Colors inside the table indicate the ring color. 1pc./pack SPQ: 10 pcs, Outer Ctn.: 200 pcs

Cushion Drill Bit for concrete, 3-pc set | ACD3S



RoHS

Code No.	Model No.	Contents	Card size (mm)	JAN (4907587)
462101	ACD3S-3.4	3.4mm 3pcs.	165×50×10	602503
462102	ACD3S-3.5	3.5mm 3pcs.	165×50×10	602510
462103	ACD3S-4.3	4.3mm 3pcs.	165×50×10	602527

SPQ: 10 sets

Cushion Drill Bit for Awl | ATD

● For drilling holes in wood, laminated wood, bamboo, gypsum board, and resin products, and for a pilot hole in a material which tends to crack easily.
● Durable straight-shank enables to drill a hole on a hard wood.

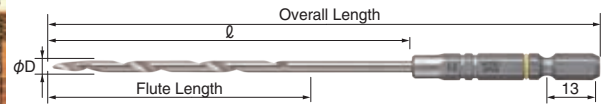

Code No.	Model No.	φD	ℓ	Flute Length	Overall Length	(mm)	Card size (mm)	JAN (4907587)
463001	ATD-4	3.0	93	62	143	200×35×12	602015	
463002	ATD-5	4.0	103	76	153	200×35×12	602022	
463003	ATD-6	5.0	113	80	163	200×35×12	602039	

※Colors inside the table indicate the ring color. 1pc./pack SPQ: 10 pcs, Outer Ctn.: 200 pcs

Pilot Hole Drill Bit | AHD NEW

● Can also be used with 220USB (Type-A bit).
● Reverse-taper spiral shape with low drilling load.
● Rust-resistant with electroless nickel plating, smooth sliding to prevent clogging of wood chips.
● Cutting edge design enables easy control of drill feed rate. RoHS



AHD-3 AHD-4

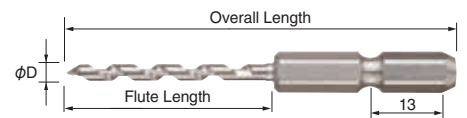

AHD-3



AHD-4

Code No.	Model No.	φD	Flute Length	Overall Length	(mm)	Card size (mm)	JAN (4907587)
462901	AHD-3	2.8	30	65	160×35×8	028051	
462902	AHD-4	3.6	45	80	160×35×8	028068	

SPQ: 10 pcs

HAND TOOLS

INDUSTRIAL BITS

CONSTRUCTION BITS

RECIPROCATING SAW BLADES

ELECTRIC TOOLS

AIR TOOLS

AIR NIPPERS

STATIC SOLUTIONS

GASOLINE ENGINE TOOLS

HAND TOOLS

INDUSTRIAL BITS

CONSTRUCTION BITS

RECIPROCATING SAW BLADES

ELECTRIC TOOLS

AIR TOOLS

AIR NIPPERS

STATIC SOLUTIONS

GASOLINE ENGINE TOOLS

Damaged Screw Remover | NEJ-1/-2/-3



● Bit rotating direction is counterclockwise for both drilling and screw removal (loosening direction).

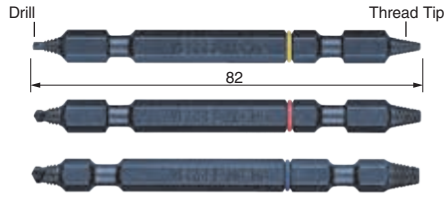

Code No.	Model No.	Compatible Screw	Overall Length	Drill Tip Dia.	Thread Tip Dia.	H (mm)	JAN (4907587)
485424	NEJ-1	M3~M4	82	1.8	1.7	6.35	346452
485425	NEJ-2	M5~M6	82	2.7	2.6	6.35	346469
485426	NEJ-3	M6~M8	82	3.7	3.6	6.35	346476

※Colors inside the table indicate the ring color. Card size:135×50×8 mm SPQ: 10 pcs, Outer Ctn.: 200 pcs

Damaged Screw Remover, 3-pc set | NEJ-123

Code No.	Model No.	Contents	JAN (4907587)
485428	NEJ-123	NEJ-1/NEJ-2/NEJ-3 1pc. each	346490

Card size:135×63×8 mm SPQ: 10 sets, Outer Ctn.: 200 sets

ONE POINT | NEJ-1/-2/-3

Remove the distorted screws easily!!

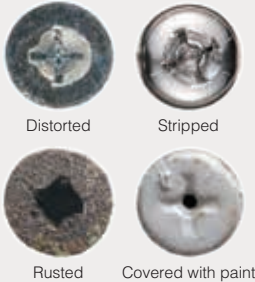

Both drilling and screw removal are by the same direction (counterclockwise).

※Cannot be used with high hardness screws or reverse screws.

Damaged Screw Remover Bit "Slim Type" | NEJ-4/-5

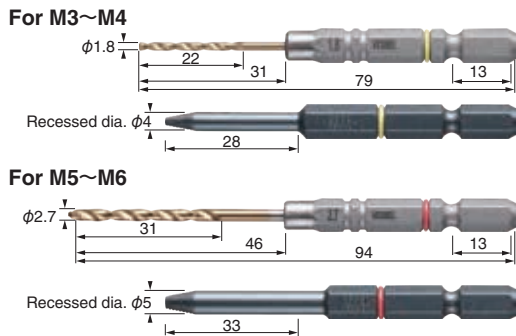

RoHS

Code No.	Model No.	Compatible Screw	Set contents	JAN (4907587)
485429	NEJ-4	M3~M4	Drill bit (φ1.8), Thread tapered bit (φ4)	010872
485430	NEJ-5	M5~M6	Drill bit (φ2.7), Thread tapered bit (φ5)	010889

Card size:160×63×8 mm SPQ: 10 sets Outer Ctn.: 100 sets

Damaged Screw Remover Bit "Slim Type" Set | NEJ-45

RoHS

Code No.	Model No.	Set contents	JAN (4907587)
485423	NEJ-45	NEJ-4/NEJ-5 1pc. each	010896

Card size: 160×50×12 mm SPQ: 5 sets Outer Ctn.: 50 sets

Drill Chuck Keyless Type (For power tools) | BH

● For Air tools, Electric tools.

RoHS

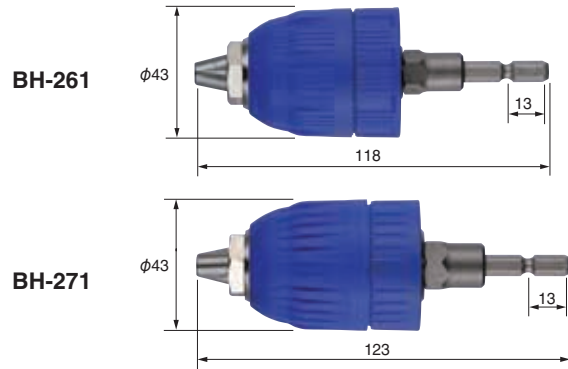

BH-261 BH-271

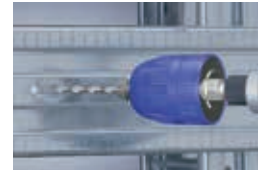

Code No.	Model No.	Content	Capacity (mm)	Card size (mm)	JAN (4907587)
486344	BH-261	Drill Chuck (Keyless)	Dia.: 0.5~10	140×80×45	356994
486343	BH-271	Drill Chuck (Keyless)	Dia.: 1.5~13	140×80×45	357700

SPQ: 5 pcs

ONE POINT | NEJ-4/-5

Slim tip-end shape good for use in deep places.



※Cannot be used with reverse screws.

Drill Chuck Key Type

BH

- For air electric screwdrivers.
- Outstanding holding strength. High precision.
- Durable shaft unit.
- Keyed type...Attach and detach the tip tool with enclosed key.
- Hybrid type...Dual use type with or without key.

RoHS

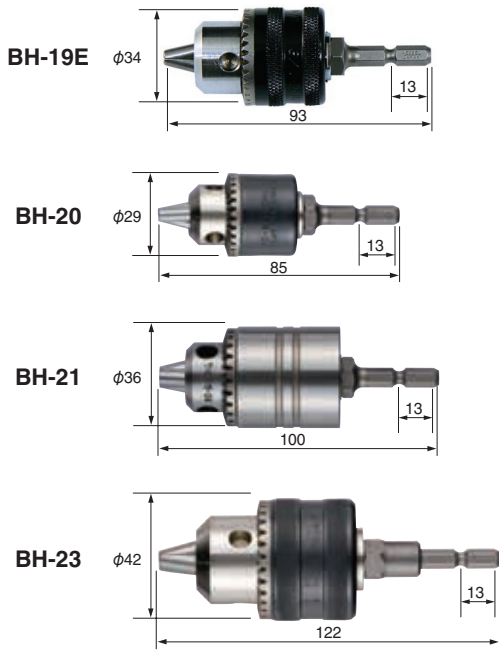

Code No.	Model No.	Contents	Capacity (mm)	Card size (mm)	JAN (4907587)
485311	BH-19E	Drill Chuck (Keyed) ·Key	Dia.: 1.0~10	140×80×37	359049
486337	BH-20	Drill Chuck (Keyed) ·Key	Dia.: 0.8~6.5	140×80×31	355324
486338	BH-21	Drill Chuck (Hybrid) ·Key	Dia.: 1.5~10	140×80×38	355331
486340	BH-23	Drill Chuck (Keyed) ·Key	Dia.: 1.5~13	140×80×44	355836

SPQ: 5 pcs

Spare Shaft for Drill Chuck

BH



BH-24 BH-29

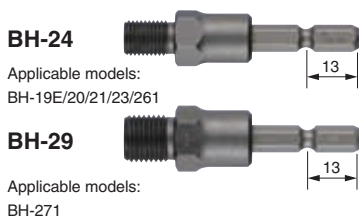

Code No.	Model No.	Contents	Thread size	Card size (mm)	JAN (4907587)
486341	BH-24	Spare shank · Reversing screw	3/8-24UNF	135×35×17	356062
486349	BH-29	Spare shank · Reversing screw	1/2-20UNF	135×35×17	356987

Applicable model of the enclosed thread parts for BH-24 - Small: BH-20 Big: BH-19E / 21 / 23 261 SPQ: 5 pcs

Drill Chuck SDS Plus type

BH-28

- For rotary hammer and hammer drills.

RoHS



Code No.	Model No.	Contents	Capacity (mm)	Card size (mm)	JAN (4907587)
486348	BH-28	Drill Chuck (Keyless)	Dia.: 1.5~13	185×100×45	356970

SPQ: 5 pcs

Drill Chuck SDS Plus type

BH

- For rotary hammer and hammer drills.

RoHS

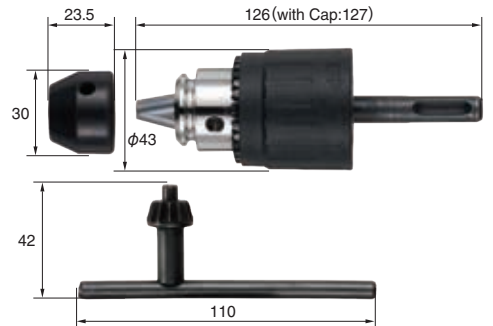

Code No.	Model No.	Contents	Capacity (mm)	Card size (mm)	JAN (4907587)
485312	BH-22H	Drill Chuck (Keyed) ·Key	Dia.: 2.5~13	185×100×45	356093

SPQ: 5 pcs

Dust-proof cap

BH-22HC

- For BH-22H.



Code No.	Model No.	Contents	Box size (mm)	JAN (4907587)
485313	BH-22HC	Dust-proof cap / 5pcs.	58×56×174	356109

SPQ: 5 pcs

HAND TOOLS

INDUSTRIAL BITS

CONSTRUCTION BITS

RECIPROCATING SAW BLADES

ELECTRIC TOOLS

AIR TOOLS

AIR NIPPERS

STATIC SOLUTIONS

GASOLINE ENGINE TOOLS

















Driver, Bit and Screw Cross-Reference

HAND TOOLS
INDUSTRIAL BITS
CONSTRUCTION BITS
RECIPROCATING SAW BLADES
ELECTRIC TOOLS
AIR TOOLS
AIR NIPPERS
STATIC SOLUTIONS
GASOLINE ENGINE TOOLS

Hand Tools	Industrial Bits	Construction Bits	Reciprocating Saw Blades	Electric Tools	Air Tools	Air Nippers	Static Solutions	Gasoline Engine Tools
JIS B 1101 JIS B 1135	JIS B 1111 JIS B 1122 JIS B 1112 JIS B 1124 JCIS 10-70	■ Slotted (Reference)	mm	mm	mm	mm	mm	mm
1.8	1.4	■ Phillips	1.2(*)	No.0	2	3	4.5(*)	6
2.5	1.6	■ Pozidriv	1.6	No.0	2.2(*)	3.1	5	8
3	1.7	■ Supadriv	1.8	No.1	2.5	3.5	5.5	10
4	2		2.1	No.1	2.6	3.8	6.2	12
4.5	2.2(ST)		2.4	No.2	2.9(ST)	4.1	6.3	14
5	1.8		2.7	No.2	3	4.5	6.8	16
5.5	—		2.9	No.3	3.1	4.8	6.8	18
6	—		2.9	No.3	3.5	5.1	6.8	20
7	—		2.9	No.4	3.5	5.5	6.8	24
8	—		2.9	No.4	4	5.8	6.8	—
9	—		2.9	No.4	4.2	6	6.8	—
10	—		2.9	No.4	4.8	6.3	6.8	—
JIS B 1176 JIS B 1177	JIS B 1180 JIS B 1181 JIS B 1123	■ Hex ■ Ball point	mm	mm	mm	mm	mm	mm
H1.5	2		1.6	H1	2	3	1.6	H1
H2	2.5		2	H2	2.5	4	2	H2
H2.5	3		2.2	H2.5	3	5	2.5	H2.5
H3	4		2.4	H3	4	6	3	H3
H4	5		2.7	H4	5	8	3.1	H4
H5	6		2.9	H5	6	10	3.5	H5
H6	8		2.9	H6	8	12	4.1	H6
H8	10		2.9	H8	10	16	4.5	H8
H10	12		2.9	H10	12	20	4.8	H10
H12	14		2.9	H12	14	24	5.1	H12
JIS B 1107 JIS B 1128 JIS B 1136 JASO F116-89	JIS B 1180 JIS B 1181 JIS B 1123	■ TORX (Reference)	mm	mm	mm	mm	mm	mm
T1	2		0.84	T1	2	—	0.84	T1
T2	2.2		1	T2	2.2	—	1	T2
T3	2.5		1.2	T3	2.5	—	1.2	T3
T4	3		1.4	T4	3	—	1.4	T4
T5	3.5		1.6	T5	3.5	—	1.6	T5
T6	4		1.7	T6	4	—	1.7	T6
T7	4.2		2	T7	4.2	—	2	T7
T8	4.8		2	T8	4.8	—	2	T8
T9	5.5		2.5	T9	5.5	—	2.5	T9
T10	6.3		2.5	T10	6.3	—	2.5	T10
T15	6.3		2.5	T15	6.3	—	2.5	T15
T20	6.3		2.5	T20	6.3	—	2.5	T20
T25	6.3		2.5	T25	6.3	—	2.5	T25
T27	6.3		2.5	T27	6.3	—	2.5	T27
T30	6.3		2.5	T30	6.3	—	2.5	T30
T40	6.3		2.5	T40	6.3	—	2.5	T40
T45	6.3		2.5	T45	6.3	—	2.5	T45
T50	6.3		2.5	T50	6.3	—	2.5	T50

(*) marked figures are in accordance with old JIS standards. (*-T) Refer to No. 1 for Truss screws. (ST) marked figures are in accordance with JIS standards. W: Refer to the old JIS standards for Whitworth screws. (*-S) marked figures are in accordance with old JIS standards for small bolts/nuts. The figures in parentheses are sizes that are considered to be used as little as possible in the case of Slotted/TORX, and less useful sizes in the case of Phillips.

 Read the instruction manual before using, and follow the instructions when using.

<p>HAND TOOLS</p> <p>Hand Tools</p> 	<p>https://www.vessel.co.jp/english/support/safety/handtools.html</p> <ul style="list-style-type: none"> • Always wear protective goggles when working with the product. • Do not use the product if any abnormality such as cracks, chipping, abrasion, or deformation is found. • Make sure of the applications, size, and usage that are suitable for the product before use. • Do not use the product in place of a hammer, crowbar, or lever. • Do not use the product in which electricity is running. • Do not modify the product. 
<p>INDUSTRIAL BITS</p> <p>Industrial Bits</p> 	<p>https://www.vessel.co.jp/english/support/safety/bit.html</p> <ul style="list-style-type: none"> • Read the instruction manual of the power tool carefully before use. • Always wear protective goggles when working with the product. • Be sure to shut off the power source before mounting or replacing bits. • Do not use the product if any abnormality such as cracks, chipping, abrasion, or deformation is found. • Never attempt to operate the power tool at no-load with the product attached. • Do not use the product in which electricity is running. • Do not modify the product. 
<p>CONSTRUCTION BITS</p> <p>Construction Bits</p> 	<p>https://www.vessel.co.jp/english/support/safety/bit.html</p> <ul style="list-style-type: none"> • Read the instruction manual of the power tool carefully before use. • Always wear protective goggles when working with the product. • Be sure to shut off the power source before mounting or replacing bits. • Do not use the product if any abnormality such as cracks, chipping, abrasion, or deformation is found. • Never attempt to operate the power tool at no-load with the product attached. • Do not use the product in which electricity is running. • Do not modify the product. 
<p>RECIPROCATING SAW BLADES</p> <p>Reciprocating Saw Blades</p> 	<p>https://www.vessel.co.jp/english/support/safety/saw_blades.html</p> <ul style="list-style-type: none"> • Check the applications and capabilities of the blade. • Read the instruction manual of the power tool carefully. • Always shut off the power source when replacing blades. • Before use, make sure that the blade is not loosely mounted. • Do not overload the product as this may cause damage to the blade. • Do not touch the blade just after stopping to use because they are hot. • Wear protective goggles and gloves when using the product. • Stop using the product if any abnormality is found. 
<p>ELECTRIC TOOLS</p> <p>Electric Tools</p> 	<p>https://www.vessel.co.jp/english/support/safety/electric.html</p> <ul style="list-style-type: none"> • Always wear protective goggles when working with the product. • Be sure to shut off the power source before mounting or replacing the tip tools. • Be sure to use a tip tool for power tools. • Do not use the product if any abnormality such as cracks, chipping, abrasion, or deformation is found. • Never attempt to operate the product at no-load with a tip tool mounted on the product. • Do not use the product in which electricity is running. • Do not disassemble or modify the product. 
<p>AIR TOOLS</p> <p>Air Tools</p> 	<p>https://www.vessel.co.jp/english/support/safety/airtools.html</p> <ul style="list-style-type: none"> • Use protective items such as a helmet, safety glasses, earplugs, dust mask, safety shoes, and others, depending on the work. • When installing or replacing the tip tools, be sure to shut off the air supply source. • Be sure to use a tip tool for power tools. • Do not use the product if any abnormality such as cracks, chipping, abrasion, or deformation is found. • Never attempt to operate the product at no-load with a tip tool mounted on the product. • Do not use the product in which electricity is running. • Do not modify the product. 
<p>AIR NIPPERS</p> <p>Air Nippers</p> 	<p>https://www.vessel.co.jp/english/support/safety/airnipper.html</p> <ul style="list-style-type: none"> • Do not touch the blade. • Always wear protective goggles and earplugs when working with the product. • When installing or replacing blades or the nipper, be sure to shut off the power source. • Do not use the product if any abnormality such as cracks, chipping, abrasion, or deformation is found. • Do not use the product in which electricity is running. • The product may cause vibration. • Do not modify the product. 
<p>STATIC SOLUTIONS</p> <p>Static Solutions</p> 	<p>https://www.vessel.co.jp/english/support/safety/staticelectric.html</p> <ul style="list-style-type: none"> • Do not use the product in the environments requiring the explosion-proof measures. • Do not use the product in an atmosphere containing flammable or combustible substances. • Do not use the product in an environment subject to rapid temperature changes or where condensation occurs. • Do not use the product in a place where it is exposed to water, solvents, oil, etc. or in a humid place. • Do not use the product with the power supply standard or the air pressure other than those specified in the specifications. • Do not disassemble or modify the product. 
<p>GASOLINE ENGINE TOOLS</p> <p>Gasoline Engine Tools</p> 	<p>https://www.vessel.co.jp/english/support/safety/gasolineengine.html</p> <ul style="list-style-type: none"> • In case any crack, chip, or deformation is observed, stop using the unit immediately. • Do not use the unit or fill fuel in presence of flame or spark. • Make sure to use two cycle oil with gasoline at mixture ratio of 1:25. • The unit emit vibration, heat and exhaust fumes. • Always wear eye, head and ear protectors when using this tool. 